

**CALIFORNIA  
ENERGY  
COMMISSION**

**FAILURE MODES AND EFFECTS  
ANALYSIS FOR HYDROGEN  
FUELING OPTIONS**

**CONSULTANT REPORT**

November 2004  
CEC-600-2005-001

# CALIFORNIA ENERGY COMMISSION

***Prepared By:***

TIAX LLC  
1601 De Anza Blvd., Suite 100  
Cupertino, CA 95014  
Contract No. 600-01-095

***Prepared For:***

Bill Blackburn  
Sandra Fromm  
***Project Managers***

Charles Mizutani  
***Manager***  
**Transportation Technology Office**

Rosella Shapiro  
***Deputy Director***  
**Transportation Energy Division**

Robert L. Therkelsen  
***Executive Director***

## **DISCLAIMER**

This report was prepared as the result of work sponsored by the California Energy Commission. It does not necessarily represent the views of the Energy Commission, its employees or the State of California. The Energy Commission, the State of California, its employees, contractors and subcontractors make no warrant, express or implied, and assume no legal liability for the information in this report; nor does any party represent that the uses of this information will not infringe upon privately owned rights. This report has not been approved or disapproved by the California Energy Commission nor has the California Energy Commission passed upon the accuracy or adequacy of the information in this report.



# **FAILURE MODES AND EFFECTS ANALYSIS FOR HYDROGEN FUELING OPTIONS**

Technical Consultant  
Report

TIAX LLC  
Shyam Venkatesh  
Stefan Unnasch

St. Croix Research  
Charles Powars

IO Mosaic  
Henry Ozog

SDV-SCC  
John Woody

**Report to**  
**California Energy Commission**  
**1516 Ninth Street**  
**Sacramento, California 95814-5512**

**Date: November 2004**

**Prepared by**  
**TIAX LLC**  
**1601 S. De Anza Blvd., Suite 100**  
**Cupertino, California 95014-5363**  
**Tel 408-517-1550**  
**Fax 408-517-1553**

Technical Consultant Report TR-03-177  
TIAX Case D0130

# PREFACE

This report was prepared by TIAX LLC for the California Energy Commission as part of the Energy Commission Contract 600-01-095, *Hydrogen Fueling Infrastructure Study*. It is a deliverable required under Task 4, *Failure Modes and Effects Analysis*. This report was prepared by TIAX and its subcontractors: St. Croix Research, the University of California at Davis, Institute of Transportation Studies, SunLine Services Group, ioMosaic, and SDV-SCC. Bill Blackburn and Sandra Fromm were the Energy Commission Project Managers. Jennifer Williams provided valuable editing of this report.

# TABLE OF CONTENTS

Preface.....	ii
Abstract.....	ix
1. Introduction and Background.....	1-1
1.1 Opportunities for Hydrogen Fueling .....	1-1
1.2 Requirements for Safety Analysis.....	1-1
1.3 Objective.....	1-2
1.4 Approach .....	1-4
1.5 Report Organization.....	1-6
2. Fueling Station Options .....	2-1
2.1 Fueling Station Equipment.....	2-2
2.1.1 Delivery from Central Hydrogen Plant .....	2-2
2.1.2 On-Site Hydrogen Production .....	2-3
2.1.3 High Pressure Compression .....	2-4
2.1.4 Compressed Gas Storage .....	2-4
2.1.5 Vehicle Fueling Dispenser .....	2-5
2.2 Fueling Station Design Basis .....	2-5
2.3 Fueling Station Documentation — Failure Modes and Effects Analysis (FMEA) Perspective .....	2-6
3. Failure Modes and Effects Analysis.....	3-1
3.1 Liquid Hydrogen Refueling Station FMEA .....	3-5
3.1.1 General Description .....	3-5
3.1.2 FMEA Results.....	3-5
3.2 Electrolyzer Refueling Station FMEA.....	3-15
3.2.1 General Description .....	3-15
3.2.2 FMEA Results.....	3-15
3.3 Steam Methane Reformer Refueling Station FMEA .....	3-24
3.3.1 General Description .....	3-24
3.3.2 FMEA Results.....	3-25
3.4 Tube Trailer Compressed Hydrogen Refueling Station FMEA.....	3-34
3.4.1 General Description .....	3-34

3.4.2	FMEA Results.....	3-34
3.5	CNG Refueling Station FMEA.....	3-42
3.5.1	General Description.....	3-42
3.5.2	FMEA Results.....	3-43
4.	Fueling Station Documentation — FMEA Inputs .....	4-1
4.1	Liquid Hydrogen Documentation.....	4-1
4.2	Electrolyzer Documentation.....	4-9
4.3	Steam Methane Reformer (SMR) Documentation .....	4-17
4.3.1	Hydrogen Generation .....	4-17
4.4	Tube Trailer Documentation .....	4-26
4.4.1	Equipment Description.....	4-26
4.5	Compressed Natural Gas (CNG) Documentation.....	4-34
4.5.1	Natural Gas Refueling Station Major Components .....	4-34
4.5.2	Refueling Station Nominal Design Basis .....	4-34
5.	Comparison of Safety Issues for Hydrogen and Other Fuels .....	5-1
5.1	Introduction.....	5-1
5.2	Hydrogen Properties.....	5-2
5.3	Fuel Property Comparisons and Implications .....	5-5
5.3.1	Properties Affecting Leakage.....	5-5
5.3.2	Buoyancy.....	5-5
5.3.3	Flammability Limits and Ignition Energy .....	5-6
5.3.4	Burning Velocity.....	5-7
5.3.5	Heating Value .....	5-7
5.3.6	Detectability .....	5-8
5.3.7	Quenching Distance .....	5-9
5.3.8	Liquid Hydrogen Properties .....	5-9
5.4	Hydrogen Compared to Natural Gas .....	5-10
5.5	Hydrogen Leak, Fire, and Explosion Risk Summary.....	5-10
6.	Conclusion.....	6-1
	References.....	R--1

# LIST OF TABLES

Table 1-1.	FMEA Team.....	1-5
Table 1-2.	Report Organization and Contents (recommended flow for reading new to hydrogen-based refueling and safety issues).....	1-7
Table 2-1.	Fueling Station Options for FMEA Study .....	2-1
Table 2-2.	Refueling Station Common Design Bases.....	2-6
Table 2-3.	Refueling Station Characteristics.....	2-6
Table 3-1.	Frequency and Consequence Ratings.....	3-3
Table 3-2.	Risk-Binning Matrix.....	3-4
Table 3-3.	Combustion Properties of Hydrogen, Natural Gas and Gasoline <sup>a</sup> .....	3-4
Table 3-4.	Liquid Hydrogen Station FMEA Results.....	3-6
Table 3-5.	Risk-Binning Matrix — Liquid Hydrogen Delivery, Compressed Gas Fueling.....	3-13
Table 3-6.	Electrolysis Station FMEA Results.....	3-17
Table 3-7.	Risk-Binning Matrix — Electrolysis Hydrogen Production, Compressed Gas Fueling .....	3-23
Table 3-8.	SMR Station FMEA Results.....	3-26
Table 3-9.	Risk-Binning Matrix — SMR Hydrogen Production, Compressed Gas Fueling .....	3-32
Table 3-10.	Tube Trailer Hydrogen Station FMEA Results .....	3-35
Table 3-11.	Risk-Binning Matrix — Tube Trailer Delivery, Compressed Gas Fueling.....	3-41
Table 3-12.	CNG Station FMEA Results.....	3-44
Table 3-13.	Risk-Binning Matrix – CNG, Compressed Gas Fueling .....	3-48
Table 4-1.	Liquid Hydrogen Equipment and Product Specification .....	4-4
Table 4-2.	Codes and Standards Regarding Compressed and Liquid Hydrogen Storage.....	4-7
Table 4-3.	Electrolyzer Equipment and Product Specification .....	4-10
Table 4-4.	Codes and Standards Regarding Compressed Hydrogen Storage .....	4-13
Table 4-5.	Electrolyzer-Based Refueling Station Operating Procedures.....	4-15
Table 4-6.	Electrolyzer-Based Refueling Station Safety Measures.....	4-16
Table 4-7.	SMR/PSA Equipment and Product Specification Summary.....	4-19

Table 4-8.	Codes and Standards Regarding Compressed Hydrogen Storage .....	4-22
Table 4-9.	SMR-Based Refueling Station Operating Procedures .....	4-24
Table 4-10.	SMR-Based Refueling Station Safety Measures .....	4-25
Table 4-11.	Tube Trailer and Compressed Hydrogen Equipment and Product Specification .....	4-27
Table 4-12.	Codes and Standards Regarding Compressed Hydrogen Storage .....	4-30
Table 4-13.	Tube Trailer Delivery-Based Refueling Station Operating Procedures .....	4-32
Table 4-14.	Tube Trailer Delivery-Based Refueling Station Safety Measures .....	4-33
Table 4-15.	CNG Fueling Station Common Design Bases .....	4-34
Table 4-16.	Compressed Natural Gas Equipment and Product Specification.....	4-36
Table 4-17.	Codes and Standards Regarding Compressed Natural Gas Storage...	4-39
Table 5-1.	Properties of Hydrogen and Other Current and Potential Automotive Fuels <sup>25</sup> .....	5-3
Table 5-2.	Energy Release Following Ignition of Hypothetical Uniform Fuel-Air Mixtures in an 85-m <sup>3</sup> Garage .....	5-8
Table 5-3.	Summary Comparison of Key Hydrogen and Natural Gas Safety Implications.....	5-11
Table 5-4.	Hydrogen Properties and Characteristics that make it more Prone or Less Prone to Leaks, Fires, and Explosions Relative to Other Fuels.....	5-12



# LIST OF FIGURES

Figure 1-1.	The Safety Analysis Included a Review of Safety Issues for All Fuels, Analysis of Hydrogen and CNG Fueling Systems, Followed by FMEA of Hydrogen and CNG Fueling Systems .....	1-5
Figure 2-1.	Key Components of Hydrogen Refueling Stations.....	2-2
Figure 4-1.	Pressure versus Enthalpy for Equilibrium Hydrogen, Illustrating Two Alternative Paths for Dispensing Compressed Hydrogen from Stored Liquid Hydrogen .....	4-2
Figure 4-2.	Illustration of Liquid Hydrogen Storage Tank Saturation Pressure Variation: Pressure Changes for Noted Conditions for Withdrawal of Liquid, Vapor, or Liquid-vapor Mixture .....	4-3
Figure 4-3.	Process Flow Diagram for Liquid Hydrogen Refueling .....	4-5
Figure 4-4.	Piping and Instrumentation Diagram for Liquid Hydrogen Refueling .....	4-6
Figure 4-5.	Liquid Hydrogen-Based Refueling Station Site Plan.....	4-8
Figure 4-6.	Electrolyzer-Based Refueling Station Process Flow Diagram.....	4-11
Figure 4-7.	Piping and Instrumentation Diagram for Electrolyzer-Based Refueling.....	4-12
Figure 4-8.	Electrolyzer-Based Refueling Station Site Plan .....	4-14
Figure 4-9.	SMR-Based Station Process Flow Diagram .....	4-20
Figure 4-10.	Piping and Instrumentation Diagram for Steam Methane Reforming-Based Refueling .....	4-21
Figure 4-11.	SMR-Based Refueling Station Site Plan.....	4-23
Figure 4-12.	Tube Trailer Delivery-Based Refueling Station Process Flow Diagram .....	4-28
Figure 4-13.	Piping and Instrumentation Diagram for Tube Trailer Delivery-Based Refueling .....	4-29
Figure 4-14.	Compressed Hydrogen Delivery-Based Refueling Station Site Plan ....	4-31
Figure 4-15.	Compressed Natural Gas Refueling Station Process Flow Diagram ....	4-37
Figure 4-16.	Piping and Instrumentation Diagram for Compressed Natural Gas Refueling.....	4-38
Figure 4-17.	Compressed Natural Gas Refueling Station Site Plan.....	4-40
Figure 5-1.	Hydrogen is Substantially More Buoyant than Air and Other Current and Potential Automotive Fuels .....	5-6



# ABSTRACT

Hydrogen has generated considerable interest in California and nationwide as a vehicle fuel to address clean air goals and petroleum dependency issues. The successful proliferation of hydrogen-fueled vehicles statewide will require expansion of the network of hydrogen fueling stations. Safe practices in production, storage, distribution, and end-use of hydrogen are essential for the successful introduction of hydrogen vehicles.

The objective of this report is to develop a safety analysis that will be useful for stakeholders involved in the development, approval, procurement, and operation of these stations and the hydrogen vehicles.

Specifically, this report addresses:

- Key safety issues related to the design, installation, and operation of four types of hydrogen fueling stations and a compressed natural gas (CNG) fueling station (delivered liquid hydrogen, on-site electrolysis, on-site reformation of natural gas, and delivered compressed hydrogen gas).
- Key hydrogen fueling station failure modes typical of selected fueling stations.
- Assignment of risk level to failure modes and provides, where necessary and applicable, recommendations for mitigating the risk level.
- Key safety issues associated with the different fueling approaches.
- Information on unique properties of hydrogen necessary for a detailed understanding of the fuel.

A top-level safety analysis was performed using the Failure Modes and Effects Analysis (FMEA) technique – a powerful engineering tool that helps to identify potential problems that may exist in a product or process before they occur.

Generic designs for the five types of fueling stations presented in this report, as well as other information available to the FMEA team, provided the basis for the analysis. The FMEA was performed by a panel with expertise on various aspects of the hydrogen fueling station, including engineering, construction, operation, and the identification of potential failure modes. The panel participants also had experience in implementing design changes to facilitate safety improvements for fueling systems.

The results of the safety analysis are presented in a standard FMEA tabular-format. While there are differences in each of the five station types that were considered, the over-arching safety issue is the explosive and flammable properties of hydrogen. Other safety issues arise from the presence of high-pressure compression and storage systems and the presence of a cryogenic liquid in the case of liquid hydrogen. The FMEA team observed that existing designs and installations followed good engineering

practices that address safety concerns. However, the team also noted that existing systems are very few in number and are often demonstration systems.

For the five types of stations, safety risk was classified into high, medium, and low risk categories using a risk binning technique (the process of categorizing the relative risk of events by assigning a “bin” number from a frequency-consequence matrix). The number of top-level failure modes ranged from 35 to 44 for the four types of hydrogen energy stations. Twenty-six top-level failure modes were identified for the CNG fueling station; however, only one failure mode was assigned to the high-risk category. Where applicable, the report includes recommendations to either prevent the failure mode from occurring or to lower the overall risk level.

# **1. INTRODUCTION AND BACKGROUND**

This report is the second volume in a series of five produced by contractors for the California Energy Commission. Its intent was to examine a variety of issues related to hydrogen fueling infrastructure. The report provides information on the factors affecting the safety of hydrogen fueling stations. It includes a review of fuel properties, which serves as an input to a Failure Modes and Effects Analysis (FMEA) of different hydrogen fueling systems.

## **1.1 Opportunities for Hydrogen Fueling**

Increased interest in hydrogen as a vehicle fuel may spur construction of more hydrogen fueling stations in California. These fueling stations may be built as part of vehicle demonstration programs sponsored by the U.S. Department of Energy (DOE), South Coast Air Quality Management District, and others, or to meet California Air Resources Board (ARB) requirements for low or zero emission transit buses or passenger cars. The ARB's regulations for transit buses require buses purchased in the future to achieve lower emission levels than today's diesel buses. Some transit agencies are opting to meet the requirement with hydrogen fuel cell buses (ARB 1999a). Automobile manufacturers may also use hydrogen fuel cell vehicles to meet some of the ARB's requirements for zero emission vehicles (ARB 1999b).

In April 2004, Governor Schwarzenegger signed Executive Order S-7-04, establishing a California Hydrogen Highway Network and outlining his vision of expanding the use of hydrogen for transportation and other sectors. Aimed at installing more than 100 hydrogen fueling stations by 2010, the need for a well grounded understanding of hydrogen safety issues is greater than ever.

## **1.2 Requirements for Safety Analysis**

Safe practices in the production, storage, distribution, and use of hydrogen are essential for the successful proliferation of refueling stations for hydrogen vehicles. Insurability of such stations also hinges on the safe practices adopted. To avoid safety hazards it is necessary to implement practices that, if adopted early in the development of a fueling station project, will provide an environment where safety is an integral component. One such practice is to develop a safety plan that identifies immediate (primary) failure modes as well as any secondary failure modes that may result from other failures. In such a plan, every conceivable failure is identified, from catastrophic failures to benign collateral failures.

Safety plans for fueling stations will be based on Identification of Safety Vulnerabilities, referred to as ISV. The safety analyses, or ISV, can consist of an FMEA, hazard analysis (HazOp), or probability risk assessment (fault tree analysis). The three methodologies are all established industry standards for reliability engineering. The

purposes are to analyze design components for safety hazards and to demonstrate an understanding and anticipation of component failures. The most important objective is the prevention of problems before they occur.

A FMEA identifies significant safety concerns in advance, before the project is fully implemented. The most important objective of the FMEA is the prevention of problems through the identification of areas that are prone to failure. If a failure does occur, the FMEA will contribute to minimizing the effects of that failure.

Prior to performing the ISV, information is compiled for the review team. Pertinent information includes:

- Component specifications and configurations
- Component interaction information
- Operating procedures
- Equipment types

The DOE requires a safety analysis for all of the fueling stations that will be built under its vehicle and infrastructure demonstration program (DOE 2003a). The requirements for these analyses are documented by DOE (DOE 2003b). This report could facilitate the planning process for more detailed site-specific safety analyses for vehicle demonstration programs.

### **1.3 Objective**

The objective of this report is to develop a safety analysis that will be useful for stakeholders involved in the development, approval, procurement, or operation of infrastructure for hydrogen-fueled vehicles. This report covers a range of hydrogen fueling options and also addresses some safety aspects for other fuels. After reviewing candidate approaches for this study with stakeholders, the project team and sponsors agreed that the analysis in this report should be aimed at the potential operators and permitting authorities of a hydrogen fueling station, rather than at the installers or technology developers who already have extensive experience with fueling systems.

An FMEA is a method of identifying safety issues (or problems in manufacturing processes) before they occur. These efforts are often part of the quality system in a design process. FMEAs typically can be categorized into four types: System, Design, Process, and Service. The Process FMEA, analyzes the activities and steps involved with a system. The Design FMEA analyzes equipment, controls, operating procedures, safety protocols, and other design parameters. The analyses contained in this report follow the steps from hydrogen supply through dispensing. Specific aspects of fueling station designs were assumed by the FMEA team, which makes the analysis in this study a hybrid of a Process and Design FMEA. The potential outcome is a ranked list of failure modes, a potential list of system functions that could detect failure modes, and a

list of actions to eliminate failure modes or safety issues. Several references exist that describe the FMEA process (e.g., Stamatus, McDermott).

A more detailed FMEA based on one specific fueling station design was also considered in lieu of the format described above. This approach was avoided for several reasons. First, publishing an FMEA for a specific fueling station requires the documentation of design details, which raises concerns over the dissemination of confidential information. Second, publishing an analysis of the safety issues associated with an existing fueling system might result in unforeseen liability issues. Third, the project team observed that most FMEAs performed for industry are generated as a tool to improve the safety of a system or process and are not released to the public. Finally, a very detailed FMEA would provide an overload of information to most readers, and the analysis would become obsolete as fueling station designs evolve.

The FMEAs in this study are not intended to serve as a comparison of the safety risks of different fuel supply options. The FMEA method is intended to identify recommendations for improving safety and does not provide a quantification of the relative safety of one fuel supply option compared with others. A numerical quantification of the risk of injury from one or more types of facilities could be accomplished with a fault tree analysis. However, such an analysis would require far more detailed information, including that needed for further site and equipment design, than is presented in this study.

This report includes an FMEA of fueling stations with four different hydrogen supply options as well as compressed natural gas (CNG) fueling.

The fueling options included in this report are:

1. Delivery of liquid hydrogen, liquid storage, vaporization, gas compression, gas storage and dispensing
2. Delivery of electricity, electrolysis, gas compression, storage and dispensing
3. Delivery of natural gas by pipeline, reforming, gas compression, storage and dispensing
4. Delivery by compressed hydrogen tube trailers, gas compression, storage, and dispensing

The CNG fueling system includes the following:

5. Delivery of natural gas by pipeline, compression, storage and dispensing

A review of safety issues associated with other fuels is also included to inform decision-makers of the different risks associated with gaseous and liquid fuels. The issues associated with fuel properties, flammability ranges, and other safety properties are discussed for hydrogen, CNG, liquid hydrogen, LPG, methanol, gasoline, and diesel.

## 1.4 Approach

The FMEA process typically is applied to a specific design, which is documented by a complete drawing package. Accurate quantitative results are produced when reliable statistics are available to characterize the appropriate initiating and contributing failure events; however, this report is based on a generic design of each type of fueling station noted above. Specific designs, while available to a limited extent to the FMEA team, would shift the focus of the report from a broad guideline to a site-specific document. The failure quantification process for an FMEA based on generic design is less straightforward, since statistical data for design specific initiating events are unknown and may have to be approximated. This is also true for early stage conceptual designs, as in the case of some of the hydrogen fueling stations.

The generic approach presents a top-down high-level FMEA for the four types of hydrogen refueling stations and the CNG station discussed in this report. This preliminary approach is suitable when specific components, design, installation, and operational details have not been chosen. The objective of this approach is to identify the most likely failure modes that will be applicable to all hydrogen refueling stations. It identifies and ranks the components and processes with the highest safety risks, the specific causes and effects of the risks, design approaches and/or operating procedures to mitigate the risks, and the relationship of the risks to current or recommended codes and standards. Furthermore, the FMEA for the hydrogen fueling station can also be used as a qualitative comparison of the risks of different hydrogen fueling options as compared to natural gas fueling.

Figure 1-1 shows the steps involved in the top-down safety analysis followed in this report. A generic design in the form of generic process flow diagrams (PFDs), piping & instrumentation diagrams (P&IDs), operating procedures, site plans, etc., was completed for each fueling option with enough detail for the FMEA team to perform the high-level analysis.

The team developed baseline risk scenarios for each fueling system. Section 3 presents the baseline risk analyses in the form of FMEA worksheets, which were later used by the analysis team. A facilitated team meeting conducted the FMEA. Table 1-1 shows the FMEA team members.



Top-down Fueling System Safety Analysis			
	Define Fuel Supply Options	System Analysis	Safety Analysis
CH	Tube Trailer LH <sub>2</sub> Delivery NG Steam Reformer Electrolyzer	<ul style="list-style-type: none"> <li>u Fuel properties</li> <li>u Fuel system description</li> <li>u Process flow diagram</li> <li>u Representative key features P&amp;ID</li> <li>u Site Plan</li> </ul>	<ul style="list-style-type: none"> <li>u Develop scenarios</li> <li>u Conduct FMEA meeting</li> <li>u Evaluate risks, effects, and mitigation measurements</li> <li>u Identify alternate configurations</li> </ul>
	CNG		
Other Fuels	Gasoline Diesel LPG Liquid Hydrogen (LH <sub>2</sub> )	<ul style="list-style-type: none"> <li>u Fuel properties</li> <li>u Fuel system description</li> </ul>	<ul style="list-style-type: none"> <li>u Identify parameters that affect safety</li> </ul>

**Figure 1-1. The safety analysis included a review of safety issues for all fuels, analysis of hydrogen and CNG fueling systems, followed by FMEA of hydrogen and CNG fueling systems.**

**Table 1-1. FMEA Team**

Participant	Organization
Henry Ozog – FMEA facilitator	ioMosaic
Shyam Venkatesh	TIAX
Stefan Unnasch	TIAX
Charles Powars	St. Croix Research
Anthony Eggert	U.C. Davis ITS
Jonathan Weinert	U.C. Davis ITS
Todd Suckow	California Fuel Cell Partnership
John Woody	SDV-SCC
John Williams	Sunline Services Group

During the sit-down FMEA meeting, the team reviewed each of the risk scenarios and discussed a rating for the likelihood of the safety event occurring, the consequences of the event, and the potential for safety systems preventing the event from occurring. Recommendations and mitigation opportunities were identified where the FMEA team observed opportunities to address safety risks.

## **1.5 Report Organization**

Table 1-2 outlines the analysis of safety issues followed the sequence of efforts. Since the primary objective of this effort was to complete an FMEA for different fueling options, the report focuses firstly on the selection of fueling options. Section 2 describes hydrogen fueling station technology options, including the basic station types and their associated requirements and tradeoffs, and the principal equipment. Section 3 addresses hydrogen fueling station permitting (including potentially applicable codes and standards), procurement and contracting, installation, training, and related subjects. Finally, Section 4 provides documentation of the fueling system, followed by a comparison of the safety issues associated with gaseous and liquid fuels. This order of presentation is appropriate for the experienced reader. Table 1-2 depicts a reading order for readers not familiar with hydrogen fueling equipment or fuel safety issues.

**Table 1-2. Report Organization and Contents (recommended flow for reading new to hydrogen-based refueling and safety issues)**

Report Section	Description																																	
Section 5 Comparison of Safety Issues for Hydrogen and Other Fuels																																		
Section 2 Fueling Station Options	<table border="1"> <thead> <tr> <th>Station Type</th> <th>Fuel</th> </tr> </thead> <tbody> <tr> <td>1 Liquid Hydrogen</td> <td>Hydrogen</td> </tr> <tr> <td>2 On-Site Electrolysis</td> <td>Hydrogen</td> </tr> <tr> <td>3 On-Site Reforming</td> <td>Hydrogen</td> </tr> <tr> <td>4 Tube Trailer Delivery</td> <td>Hydrogen</td> </tr> <tr> <td>5 CNG</td> <td>Natural Gas</td> </tr> </tbody> </table>		Station Type	Fuel	1 Liquid Hydrogen	Hydrogen	2 On-Site Electrolysis	Hydrogen	3 On-Site Reforming	Hydrogen	4 Tube Trailer Delivery	Hydrogen	5 CNG	Natural Gas																				
	Station Type	Fuel																																
1 Liquid Hydrogen	Hydrogen																																	
2 On-Site Electrolysis	Hydrogen																																	
3 On-Site Reforming	Hydrogen																																	
4 Tube Trailer Delivery	Hydrogen																																	
5 CNG	Natural Gas																																	
Section 4 Fueling Station Documentation FMEA Inputs																																		
Section 3 Failure Modes and Effects Analysis	<p>Process: Compressed Hydrogen Tube Trailer                  Study Section: Hydrogen Storage                  Design Intent: Store up to 30 kg of hydrogen at 6,250 psig</p> <p style="text-align: right;">Date: July 10, 2003</p>																																	
	<table border="1"> <thead> <tr> <th>No.</th> <th>Failure Mode</th> <th>Cause</th> <th>Effects</th> <th>Controls</th> <th>F</th> <th>C</th> <th>Recommendation</th> </tr> </thead> <tbody> <tr> <td>19</td> <td>Fill storage tank on cold day to 6,250 psig</td> <td>Overheat gas with sun exposure</td> <td>Overpressure storage tank MAWP 7,333 psig</td> <td>Maximum pressure due to thermal expansion is 7,290 psig based on 50°C increase in temperature</td> <td>M</td> <td>L</td> <td></td> </tr> <tr> <td>20</td> <td>Relief device failure (on cylinders) fails open</td> <td>Mechanical Failure</td> <td>Release of hydrogen to atm via vent stack</td> <td>Vent stack is a minimum of 15 feet above ground</td> <td>L</td> <td>L</td> <td>Storage system should contain relief devices</td> </tr> <tr> <td>21</td> <td>Storage tank failure</td> <td>Mechanical failure, corrosion, hydrogen embrittlement</td> <td>Release of hydrogen to atm and potential fire or explosion</td> <td>Storage tank MAWP 7,333 psig</td> <td>L</td> <td>H</td> <td></td> </tr> </tbody> </table>		No.	Failure Mode	Cause	Effects	Controls	F	C	Recommendation	19	Fill storage tank on cold day to 6,250 psig	Overheat gas with sun exposure	Overpressure storage tank MAWP 7,333 psig	Maximum pressure due to thermal expansion is 7,290 psig based on 50°C increase in temperature	M	L		20	Relief device failure (on cylinders) fails open	Mechanical Failure	Release of hydrogen to atm via vent stack	Vent stack is a minimum of 15 feet above ground	L	L	Storage system should contain relief devices	21	Storage tank failure	Mechanical failure, corrosion, hydrogen embrittlement	Release of hydrogen to atm and potential fire or explosion	Storage tank MAWP 7,333 psig	L	H	
	No.	Failure Mode	Cause	Effects	Controls	F	C	Recommendation																										
	19	Fill storage tank on cold day to 6,250 psig	Overheat gas with sun exposure	Overpressure storage tank MAWP 7,333 psig	Maximum pressure due to thermal expansion is 7,290 psig based on 50°C increase in temperature	M	L																											
20	Relief device failure (on cylinders) fails open	Mechanical Failure	Release of hydrogen to atm via vent stack	Vent stack is a minimum of 15 feet above ground	L	L	Storage system should contain relief devices																											
21	Storage tank failure	Mechanical failure, corrosion, hydrogen embrittlement	Release of hydrogen to atm and potential fire or explosion	Storage tank MAWP 7,333 psig	L	H																												
<p>Structured review of safety issues                  Develop recommendations</p>																																		
Section 6 Conclusion	<ul style="list-style-type: none"> <li>Summarize the objectives of the report, key findings, and present overarching recommendations</li> </ul>																																	



## 2. FUELING STATION OPTIONS

For this study, FMEAs were conducted for hydrogen fueling stations with similar design criteria but different supply options. This approach should be useful to organizations that need to build a hydrogen fueling station, even though the design criteria may differ from those selected in this study. Where feasible, the fueling station designs considered in this study reflect possible future design choices that may prove challenging to the fueling station developer. Integration with gasoline fueling equipment was assumed for the hydrogen fueling stations. When applicable, more energy efficient design choices were assumed for the hydrogen supply equipment, although existing fueling stations do not typically use such equipment.

A variety of configurations are candidates for hydrogen fueling systems. They will differ in terms of fueling capacity, hydrogen supply option, level of integration with surrounding infrastructure, and fueling equipment technology. The report on hydrogen fueling station installation guidelines prepared by the project team reviews the differences between different hydrogen supply options (Powars). Several studies also document the costs and energy consumption for different supply options (ADL, Lasher).

A total of five types of fueling stations were considered for the FMEA study. Table 2-1 summarizes the five types of stations.

Developers are pursuing many other hydrogen supply options and facility configurations. Among other supply options are pipeline delivery, mobile fuelers, on-site liquid fuel (methanol, ethanol, ammonia, LPG, etc.) reforming and chemical hydrides, chemical reactants. The project team and sponsors selected the supply options in Table 2-1 based on their uniqueness, observations on the type of fueling stations that are being installed and studied in fueling station development programs, and the ability to obtain detailed information on each fueling station type. Analysis of similar options such as on-site reforming of natural gas and LPG was avoided. Resource limitations prevented the project team from addressing other supply options.

**Table 2-1. Fueling Station Options for FMEA Study**

Fuel	Station Type
Hydrogen	1. Liquid hydrogen delivered and stored onsite, gas compressor
Hydrogen	2. Onsite electrolyzer, 10-atm output, gas compressor
Hydrogen	3. Onsite steam methane reformer (SMR), 10 atm output, gas compressor
Hydrogen	4. Compressed hydrogen delivered onsite by tube trailer, gas compressor
Natural Gas	5. Compressed natural gas (CNG), gas compressor

## 2.1 Fueling Station Equipment

Gaseous fuel stations typically include equipment for the supply, compression, storage, and dispensing of fuel. Figure 2-1 presents an overview of the general components of the fueling stations considered in the FMEA analysis. The designations in Figure 2-1 and Table 2-1 are used to track the FMEA scenarios in Section 3. Section 4 includes details of the station configuration, site requirements, and equipment.

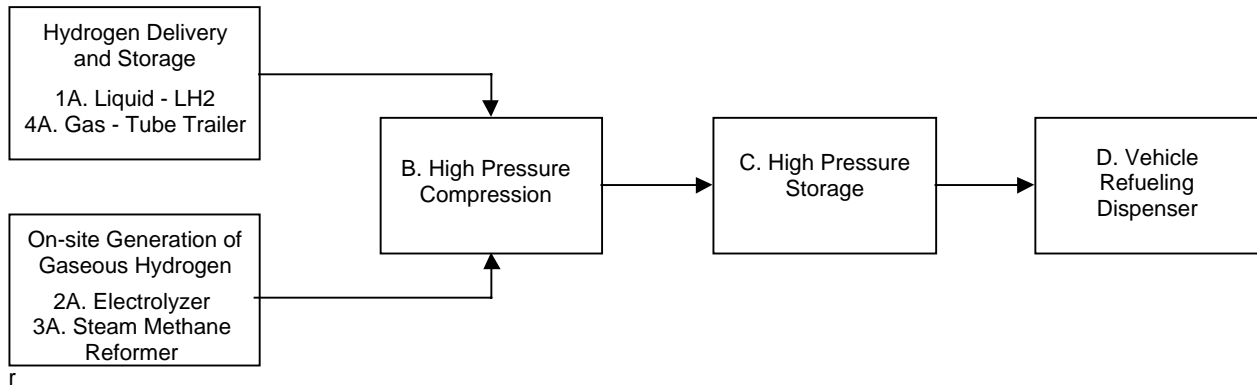

**Figure 2-1. Key Components of Hydrogen Refueling Stations**

### 2.1.1 Delivery from Central Hydrogen Plant

#### Liquid Hydrogen

Liquid hydrogen is delivered to the fueling station by a cryogenic tank truck and transferred as a liquid to an above ground station tank. Since liquid hydrogen is denser than compressed gas, considerably more hydrogen is transported as a liquid in tank trucks than as a compressed gas in tube trailers. The delivered liquid is maintained at approximately  $-250^{\circ}\text{C}$  ( $-420^{\circ}\text{F}$ ) in a vacuum-jacketed vessel at the station. For the station design considered in the FMEA, the hydrogen passes through a compressor and is stored in pressure vessels. The liquid can be warmed in a heat exchanger and converted to gas before being compressed or drawn from the liquid tank vapor space and fed to the compressor.

#### Compressed Gas Tube Trailer

Several compressed gas delivery strategies have been developed for hydrogen vehicle fueling. These include mobile fuelers, or “refuelers,” with and without on-board compressors, as well as conventional tube trailer delivery of hydrogen. Conventional tube trailer delivery with on-site compression was analyzed. Tube trailer delivery can serve as a transition strategy while equipment for other delivery options is procured. The option also requires a relatively low-capital expense for the hydrogen supply.

Hydrogen gas is delivered to the fueling station in a tube trailer, a pack of pressurized cylinders initially at 217 atmospheres, or atm (3,200 psi) connected by a manifold, which is hauled by a tractor truck. The hydrogen is transferred from the tube trailer by a compressor to buffer storage tanks at 425 atm and then dispensed to the tank of the vehicle. The trailer assembly is not a permanent fixture and is refilled off-site. Connections to the trailer utilize flexible hose.

## **2.1.2 On-Site Hydrogen Production**

### **Electrolysis**

Electrolysis is the process of using electric energy to produce chemical changes. For hydrogen production, an electric current is passed through an electrolysis cell containing water and an appropriate electrolyte. Hydrogen gas is produced at one electrode (cathode) and oxygen gas is produced at the other electrode (anode). The gases are collected in separate collection chambers and compressed or vented as required.

Alkaline and solid polymer electrolyte membranes (SPEM)<sup>1</sup> are the two most common methods of electrolysis used for hydrogen production. For the FMEA, the electrolyzer-based hydrogen refueling station is an alkaline electrolyzer. Alkaline is the oldest electrolysis technology and the one most typically used for large-scale electrolytic hydrogen production. A 10 atm electrolyzer was considered in the FMEA. Most electrolyzers in today's fueling applications operate at atmospheric pressure. More advanced designs operate at elevated pressures in order to reduce compression energy requirements. Alkaline electrolyzers operate at temperatures between 80 and 145°C.

### **Steam Methane Reforming**

In a steam reformer, hydrocarbons react with water vapor to make hydrogen. The initial reaction products are principally hydrogen plus carbon monoxide, which react with additional water vapor in a shift reactor to produce hydrogen plus carbon dioxide. Natural gas is the most commonly used feedstock, although reformers can be designed to process almost any hydrocarbon. Steam methane reformers use methane (the principal constituent of natural gas) and steam to generate hydrogen. The overall reaction can be written as:

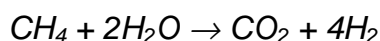

<sup>1</sup> Also referred to as proton exchange membrane (PEM)

The reformer operates typically around 800°C. This temperature is achieved by combusting waste gas and natural gas. A reformer system includes gas clean up and hydrogen purification systems. The reformer system considered in the FMEA operates at 10 atm and provides 10 atm reformer product (reformate) to a pressure swing adsorption (PSA) system which separates most of the hydrogen from the reformate stream. The PSA system provides high purity hydrogen to the compressor at close to 10 atm, which reduces the energy requirements for the hydrogen compressor. This configuration represents a more state-of-the-art design than reformers that operate at atmospheric pressure and one more typical in current installations. The high-pressure reformer represents a more common future design.

### ***2.1.3 High Pressure Compression***

The physical properties of hydrogen, fuel purity specifications for fuel cell vehicles, hydrogen supply, and vehicle fueling pressure affect the requirements for compressors. Section 4 discusses compressor requirements, which vary among the hydrogen and CNG supply options. The principal factors to consider in a fuel station design include the type of compressor, motor, and pressure requirements. Compressor design options include the cylinder lubrication system, cooling system, motor, and piston configuration. For hydrogen compression, oil-free compressors are generally preferred over oil lubricated designs because lubricating oil is a source of contamination for the hydrogen. Cooling between compression stages can be accomplished with air or coolant. A piston compresses the gas in each stage. The gas is then cooled before it enters the next stage. For passenger cars fueling at 340 atm (5,000 psi), the hydrogen compressor would need to provide hydrogen at up to 425 atm (6,250 psi). CNG is stored at 305 atm (4,500 psi) for vehicle fueling at 245 atm (3,600 psi).

In the configuration for this study, the compressor feeds the high-pressure storage tanks, which in turn feed the dispenser for fast-fill fueling. Typical hydrogen compressors will have more stages than CNG compressors because of higher output pressure and the physical properties of hydrogen. The gas properties of hydrogen also affect the exit temperature for each compression stage. Compressors need to be designed to limit the exit temperature for each stage in order to prevent thermal stresses.

The compressor exit temperature needs to be limited to approximately 300°F to insure long piston life. Diaphragm compressors are an alternative to piston compressors. Diaphragm compressors are often preferred for hydrogen service because they tend to provide a better seal than piston compressors.

### ***2.1.4 Compressed Gas Storage***

All fueling station designs considered in the FMEA include high-pressure gas storage prior to the dispenser. The capacity varies among the different supply options.



Hydrogen is stored at a nominal pressure of 425 atm (6,250 psi) for vehicle fueling at 340 atm (5,000 psi). CNG is stored at 305 atm (4,500 psi) for vehicle fueling at 245 atm (3,600 psi). The fuel storage is configured in a cascade system with gas stored in three separate vessels in order to provide fast fill fueling.

### ***2.1.5 Vehicle Fueling Dispenser***

The fueling dispenser contains controls, fuel metering, and a connection for the fueling hose. It draws fuel from the cascaded high-pressure gas storage system. The controls on the dispenser determine the final fill pressure on the vehicle. The dispenser meters the quantity of fuel transferred to the vehicle to achieve the design pressure, (340 atm for hydrogen, 245 atm for CNG) at 20°C (68°F). Section 4 describes the approach for achieving temperature compensated filling differs for hydrogen and CNG stations. The dispenser uses a heat-of-compression algorithm to predict the gas quantity needed to provide a full fill, or the fullest possible fill, within tank pressure and temperature constraints. The fueling nozzles have a lever that actuates a three-way valve allowing gas (that would otherwise be trapped at the end of the fill) to be vented back to the dispenser through a vent hose. This lever makes it easier to disconnect the nozzle and minimizes the leakage of flammable hydrogen from the nozzle and receptacle when the nozzle is removed.

## **2.2 Fueling Station Design Basis**

The different fueling stations under consideration share a common design basis. Tables 2-2 and 2-3 present the design basis and salient operating characteristics selected for the FMEA.

The fueling capacity is based on filling ten (10) hydrogen or CNG vehicles per day. Table 2-2 shows how the fuel fill rates reflect vehicle fuel economy and driving assumptions.

**Table 2-2. Refueling Station Common Design Bases**

	Hydrogen	CNG
Number of vehicles refueled	10 per day	
Amount of fuel per fill	3 kg (1270 scf)	15.4 kg (743 scf)
Driving per fill	185 km (115 miles)	
Vehicle refueling time	10 min/fill	
Station average consumption	30 kg/day	7430 scf/day
Nominal dispensing capacity	5 vehicles in 2 hours	
Typical fuel consumption (gasoline equivalent)	4 L/100 km (60 mpg)	7.9 L/100 km (30 mpg)

**Table 2-3. Refueling Station Characteristics**

Refueling System		Liquid Hydrogen	Electrolyzer	SMR	Tube Trailer Delivery	CNG
Fuelings/day	—	10	10	10	10	10
Compressor Flow Rate	(kg/h)	3.7	1.2	1.2	3.7	18
	(scfm)	26	8.6	8.6	26	15
Fuel Station Storage Nominal Pressure	(psi)	6,250	6,250	6,250	6,250	4,500
	(atm)	425	425	425	425	305
Vehicle Storage Nominal Pressure	(psi)	5,000	5,000	5,000	5,000	3,600
	(atm)	340	340	340	340	245
Storage type	—	Cascade	Cascade	Cascade	Cascade	Cascade
Storage capacity, gas	(kg fuel) <sup>a</sup>	24	48	48	24	120
Storage volume	(m <sup>3</sup> )	0.82	1.6	1.6	0.82	0.49

<sup>a</sup> Storage meets the following constraints: Fuel 5 vehicles in 2 hours with 30% cascade efficiency, taking into account compressor flow rate. For Electrolyzer and SMR, provides sufficient storage for 24 hours production, taking into account dispensing fuel onto vehicles.

## 2.3 Fueling Station Documentation — Failure Modes and Effects Analysis (FMEA) Perspective

Section 3 describes the FMEA process in detail. The FMEA is typically part of an overall safety plan. With the help of the FMEA, the safety plan identifies failure modes for equipment and processes, the consequences of such failures, and evaluation of existing controls and recommendations of additional controls to mitigate the risk of the identified failure modes. The FMEA is an ongoing process and must be updated every time design or process changes are made.

The FMEA presented for each of the five stations in this report has a functional top-down approach that is generally applicable to similar stations. Such an approach is appropriate when specific details of the fueling station components presented earlier are not present (and vary from station to station). While there are no standard guidelines for this level of information/documentation requirements for a top-down FMEA, the following documentation was prepared for the FMEA for the purposes of this study:

- Process flow diagram (PFD)
- Simplified piping and instrumentation diagram (P&ID)
- Site plan
- Standard operating procedures
- Safety standards and codes

It must be noted that the documentation reference above were of a very generic nature since no specific existing or planned station was under consideration. Instead, this FMEA targets all stations of a particular type and identifies the most common and minimum set of failure modes that must be of concern from a safety perspective. It should be the responsibility of the designers and operators of such stations to conduct a detailed FMEA covering at least the failure modes considered here.

Section 4 presents summaries of documentation packets for each station type. Each packet includes a brief description of the process regarding the fuel generation. In addition, there is technical material regarding the design and layout of individual stations. Section 4 also lists equipment used and its specifications, and a process flow diagram (PFD) showing the order of the material flow in the system. The report also contains a generic piping and instrumentation diagram (P&ID). Finally, it includes a chart of codes and standards regarding fuel storage as well as a site plan layout for the fueling station with regard to the aforementioned codes and standards. The FMEA team had access to more detailed design information from several actual hydrogen fueling stations. The team used the design information to confirm study assumptions about the operation of subsystems in the fueling station.



### 3. FAILURE MODES AND EFFECTS ANALYSIS

A FMEA is a systematic and structured method of identifying product and process problems, assessing their significance, and identifying potential solutions that reduce their significance. The objective of a FMEA is to look for all the ways a product or process can fail (failure modes). Each failure mode has a cause and a potential effect. Some failure modes are more likely to occur than others, and each potential effect has a relative risk associated with it. The FMEA process is a way to identify the failure modes within a process or product and to identify actions to reduce the severity, occurrence, or eliminate the cause of the failure mode. In general, the FMEA process follows a standard procedure, as detailed below:

1. Identify top level hazards/events
2. Identify related equipment/components/processes
3. Identify potential failures
4. Identify design safety
5. Identify corrective actions

An FMEA can be performed using two different approaches. The hardware, or component, analysis is the identification and analysis of ramifications of component failures. This method is a bottom-up approach, wherein failures are initiated on the subsystem level. The functional approach is a top-down method, more suitable when specific components have not yet been chosen. Industry uses both approaches. The development of the FMEA is a continuous process, and the document should evolve as the system design changes.

In a FMEA, the relative risk of a failure and its effect is determined by three factors:

- **Occurrence** — the probability or frequency of the failure occurring
- **Severity** — the seriousness of the effect of the failure mode
- **Detection** — the probability of the failure being detected before the impact of the effect is realized

In a typical FMEA, numerical rankings are assigned for each factor. The higher the ranking, the greater the potential harm posed by the failure and its effect. These rankings can be used on any scale desired. Many organizations performing FMEAs use a scale of 1 to 10; others use 1 to 5. Most FMEA practitioners believe that the minimum resolution for the scale should be 1 to 3. FMEAs are team-based. In performing a FMEA, a team is assembled of four to six individuals knowledgeable in various aspects of the process or product under evaluation.

The FMEA process consists of the FMEA team meeting and brainstorming on potential failure modes of the process or product, and identifying the cause(s) of the failure, the effect(s) of the failure and the current controls in place to detect the failure before the effect occurs. Having all the potential failure modes identified with associated causes, effects, and current controls, the FMEA team then assigns occurrence, severity, and

detection rankings to each combination. Consensus must be reached for the process to be effective. The overall measure of relative risk in a FMEA is termed the “risk priority number” (RPN). The RPN is the product of the three factors: occurrence; severity; and detection. RPNs can then be used to rank the significance of the risk posed by the failure/effect and the need for corrective actions to reduce or eliminate the potential failure mode.

As noted in the introduction section, this study is a top-down functional analysis of five types of fueling stations. Given the time and resources available for the project, a high-level FMEA was the objective of this project. The intent of this report, as stated earlier, is to facilitate the basic understanding of the following:

- Key engineering components and operating features of the five types of fueling stations
- Major failure modes associated with the key components and operation of the fueling station
- Rank relative risk of different hazard scenarios

A FMEA team comprised of five persons (on average) analyzed each of the five types of fueling stations. Prior to starting the first FMEA, the team agreed to follow a three-point scale of **low (L), medium (M), and high (H)** to rank the factors determining the relative risk of potential failures. The risk level of a particular failure mode was to be determined by assigning a scale-letter to the **frequency** of occurrence (**F**) of the failure mode and the **consequence** of the failure mode (**C**). The third factor, detection (or control or remedial action, R), was not assigned a letter-scale.

Detection (or control) defines what safety mechanisms are in place to prevent the failure mode from occurring. The key reason for not assigning risk to detection is that hydrogen fueling stations are not common place and there are no established safety standards specific to their installation and operation, and the few existing stations adopt general good engineering practices. Therefore, the team believed that by assigning a risk level to detection could lead to its misinterpretation as a standard practice. Consequently, for this study, an RPN was not calculated for each failure mode. Instead, for specific high-risk failure modes, the team provided recommendations to mitigate the risk.

Table 3-1 describes the high, medium, and low ratings. The rating for frequency or consequence for a particular failure mode may be the result of a number of other activities, each of which carries with it a risk-level rating. The cases where the high-level rating stems from the individual component events are discussed in detail as they occur in the following sections under each fueling station’s FMEA.

After the team completed the FMEA, they discussed the risks for each scenario according to the key failure modes (fires, shock hazard, etc.) and then reviewed ranked failure modes with the highest risk ratings.

**Table 3-1. Frequency and Consequence Ratings**

Frequency Rating	Description
High (H)	Almost certain to occur repeatedly
Medium (M)	Likely to occur to rarely likely to occur
Low (L)	Unlikely that failure would occur

Consequence Rating	Description
High (H)	Potential for great harm or death if someone is present within the impact area.
Medium (M)	Harm would require some medical treatment to some pain or discomfort if someone is present within the impact area
Low (L)	End user, if present, would not notice

A risk-binning matrix summarizes the consequence and frequency ratings for each FMEA. Risk-binning is one analysis tool for risk mitigation recommended by DOE for hydrogen projects. Each hazard is plotted on a frequency vs. consequence matrix, which indicates its level of risk: high, moderate, low, or negligible. High risks are considered combinations of M x H, H x M, and H x H ratings. Moderate risks are combinations of L x H, H x L, and M x M. Finally low risks are combinations of L x M, M x L, L x L, and no safety hazard or negligible risk scenarios. Table 3-2 presents the format of a risk binning matrix.

Section 2 notes that the typical hydrogen fueling station can be categorized into four sections: hydrogen production or delivery, high-pressure compression, high-pressure storage, and dispensing. Of these, dispensing hydrogen to the end user is common to all four types of hydrogen stations discussed in this study, and the associated component and operational issues are uniquely similar. Consequently, the FMEA for the dispensing section for each type of station is identical. Similar scenarios are highlighted in the FMEA worksheets. High-pressure compression and high-pressure storage are also functionally similar for the four types of stations; however, there are minor engineering design, equipment, and operational differences. The source of hydrogen (on-site production or delivery) is clearly different for each of the four types of stations and is the distinguishing feature of each type of station.

Table 3-3 presents combustion-related properties of hydrogen and compares it with other fuels. While there are differences in each type of station, the over-riding safety issues are the explosive and flammable properties of hydrogen. Other safety issues arise from the presence of high- pressure storage tanks. Asphyxiation hazards, electrical shock hazard, cryogenic and high temperature hazards from equipment were

also considered. All failure modes in this FMEA are associated with incidents leading to human injury or death. All of these failure modes apply to one of the various elements of the four sections of a station.

**Table 3-2. Risk-Binning Matrix**

Combined Risk: Consequence x Frequency		Frequency (F)			Low or Negligible Risk
		Low (L)	Medium (M)	High (H)	
		Unlikely	Likely	Anticipated	
Consequence (C)	High (H)	X	X	X	Moderate Risk
	Medium (M)	X	X	X	High Risk
	Low (L) or Negligible (-)	X	X	X	

X = Number of occurrences

**Table 3-3. Combustion Properties of Hydrogen, Natural Gas and Gasoline<sup>a</sup>**

Property	Hydrogen	Natural Gas	Gasoline
Flammability limits in air	4.1 - 75% vol	5 – 15% vol	1.4 – 7.6% vol
Minimum ignition energy	0.02 mJ	0.29 mJ	0.24 mJ
Burning velocity in NPT air	2.7-3.3 m/s	0.4 m/s	0.35 m/s
Flame temperature in air	2045°C	1877°C	2207°C
Gas molecular weight	2.016	16.5 – 17.5	68 - 80

<sup>a</sup> See documentation in Section 5.



## Commonality

Section 3.1 through 3.5 presents the results of the FMEA for each fueling station type. Processes common to the five stations are high-pressure storage and dispensing. Consequently, the results of the FMEA for these components are also similar; however, we chose to report these results repetitively for the five station types so that each station can be examined in a stand-alone fashion.

Tables 3-4 through 3-13 present the results of the FMEA. While commonalities in design and process exist, the options for several distinct design choices also exist. Specific risk scenarios that would be affected by other design choices are indicated by a ✘ symbol in the FMEA results table (3-4, 3-6, 3-8, 3-10, and 3-13). For each failure mode, specific recommendations are made wherever applicable to eliminate the failure mode or to lower the risk level.

## 3.1 Liquid Hydrogen Refueling Station FMEA

### 3.1.1 General Description

The liquid hydrogen station for which an FMEA was performed had the following key components:

- Hydrogen Delivery
- LH<sub>2</sub> Storage Tank
- Vaporizer/Heat Exchanger
- High-pressure compressor
- High-pressure storage
- Dispenser

Section 4.1 presents a detailed description of a typical liquid hydrogen-based refueling station.



### 3.1.2 FMEA Results

Table 3-4 presents the results of the FMEA. The FMEA evaluation followed the four major functions (supply, compression, storage, and delivery) required in a hydrogen fueling station. The liquid hydrogen delivery and storage (Section 1A) is unique among the supply options in this report. Liquid hydrogen converted to high-pressure gas with a compressor involves similar equipment for the other hydrogen supply options. The storage and dispensing equipment is also similar to the other fuel supply options. Risk scenarios, which would be affected by other design choices, are indicated with a ✘ symbol.

**Table 3-4. Liquid Hydrogen Station FMEA Results**

No.	Failure Mode	Cause	Effects	Controls	F	C	Recommendation
<b>Date:</b> July 7, 2003 <b>Process:</b> 1. Liquid Hydrogen <b>Study Section:</b> 1A. Liquid Delivery, Storage, and Vaporization <b>Design Intent:</b> Unload and store 2,000 gal of liquid hydrogen at 10 psig and -420°F							
1	Liquid trailer leak	Mechanical failure due to road vibration	Potential fire	Unloading inspection by station rep or driver  Hydrogen leak detectors in area	M	L	
2	Liquid trailer leak	Vehicle impact to truck while unloading damages hydrogen piping	Potential fire/explosion	Driver puts caution cones around truck.	M	M	Establish separation distance of vehicles from unloading truck.
3	Unloading hose connection leaks	Mechanical failure or improper connection	Cryogenic burn	Unloading is continuously monitored by both driver and station rep. Driver wears a Nomex suit.	M	L	Implement a leak check prior to unloading.
4	Release from connecting hose	Hose not vented prior to disconnect — human error	Cryogenic burn	Driver training and unloading checklist, using standard established procedures for unloading cryogenics	L	M	
5	Overfill storage tank	Human error or instrument failure. Truck may contain up to 10,000 gal of hydrogen and only 2,000 gal might be unloaded to storage tank	Liquid hydrogen release from pressure relief valve with potential fire	Driver training and established procedures for unloading cryogenics	H	M	Review procedures for verifying tank fill level in safety plan.
6	Inner storage tank leak	Mechanical failure	Loss of vacuum between inner and outer vessel. Release from outer vessel pressure relief device set at 0 psig	PSV vents at elevated location	L	L	

No.	Failure Mode	Cause	Effects	Controls	F	C	Recommendation
7	Overpressure storage tank	Normal boil off due to low vehicle filling (no vehicle fills in 2 weeks)	Release from pressure relief valve	Design system to allow for wide storage pressure range in LH <sub>2</sub> tank	M	L	Identify alternate use of boil off
8	Overpressure storage tank	Loss of vacuum from the liquid storage tank jacket vacuum	Release from pressure relief valve. Exceed capacity of PSV and blow rupture disc and vent entire contents of tank.	PSV vents at elevated location High pressure indication on storage tank	M	M	Monitor tank pressure rise to detect soft vacuum
9	Heat exchanger failure (vaporizer)	Icing on outside causes loss of heating	Cold vapor causes blow-by of compressor seals and is vented to stack	Stack vents at elevated location NFPA 50B requires a low temperature shutoff switch or valve in the vaporizer discharge piping	L	L	Compressor should stop if supply temperature is too cold
10	Valve to pressure build circuit closed	Pressure regulating valve fails	Damage compressor seals	Low pressure switch shuts down compressor	L	L	
11	Overpressure liquid hydrogen piping	Blocked in line filled with liquid	Fail line and release of liquid hydrogen and potential fire or explosion	Hydrostatic relief valve	L	M	Verify all potential sections of line that can be blocked in have hydrostatic relief
<p><b>Date:</b> July 10, 2003  <b>Process:</b> 1. Liquid Hydrogen  <b>Study Section:</b> 1B. Hydrogen Compression  <b>Design Intent:</b> Heat hydrogen from -420°F and compress 3.7 kg/h of hydrogen from 10 psig to 6,250 psig</p>							
12	 Compressor suction line failure	Mechanical failure of line or fitting	Release of hydrogen and potential fire	Hydrogen detectors, area electrical classification, compressor in open area	L	M	Piping in the entire system should be designed to ASME B31.3 code
13	Cooling system failure	Loss of cooling fluid	Reduce piston life above 300°F <b>No safety hazard</b>		-	-	

No.	Failure Mode	Cause	Effects	Controls	F	C	Recommendation
14 	Lubrication system failure	Loss of fluid	Compressor failure and hydrogen leak with potential fire	Low oil pressure shutdown	L	M	
15 	Seal failure	Mechanical failure	Release of hydrogen and potential fire	Seal failure alarm on compressor	L	M	
16	Compressor suction or discharge valve failure	Mechanical failure	<b>No safety hazard</b>		-	-	
17	Pressure relief device fails open	Mechanical failure	Relief valves are vented to vent stack. <b>No safety hazard</b>		-	-	
18	Valve on discharge of compressor fails closed	Mechanical failure or human error and failure of pressure relief valve to open	Overpressure compressor and rupture line, release of hydrogen and potential fire	Hydrogen detectors, area electrical classification	L	M	
19	High pressure (6,250 psig) hydrogen supply line failure	Mechanical failure	Release of hydrogen and potential fire	Hydrogen detectors, area electrical classification	L	M	
20	Compressor suction line failure	Mechanical failure of line or fitting	Release of hydrogen and potential fire	Hydrogen detectors, area electrical classification	L	M	
<b>Date:</b> July 10, 2003 <b>Process:</b> 1. Liquid Hydrogen <b>Study Section:</b> 1C. High pressure storage <b>Design Intent:</b> Store up to 30 kg of hydrogen at 6,250 psig							
21 	Fill storage tank on cold day to 6,250 psig	Fill storage tank on cold day to 6,250 psig Heat stored gas during day	Overpressure storage tank MAWP 7,333 psig, RPV releases hydrogen with potential fire or explosion	Maximum pressure due to thermal expansion is 7,290 psig based on 50°C increase in temp.	M	M	Review climate conditions in safety plan

No.	Failure Mode	Cause	Effects	Controls	F	C	Recommendation
22	Relief device failure (on cylinders) fails open	Mechanical failure	Release of hydrogen to atm via vent stack and potential fire or explosion	Vent stack is a minimum of 5 meters above grade.	L	L	Storage system should contain redundant relief devices.
23	Storage tank failure	Mechanical failure, corrosion, hydrogen embrittlement	Release of hydrogen to atm and potential fire or explosion	Storage tank MAWP 7,333 psig	L	H	Storage system should contain redundant relief devices
24	Piping leak	Mechanical failure	Release of hydrogen to atm and potential fire or explosion	NFPA 50A setback distances	L	H	
25	Compressed gas storage tank failure	External fire due to large spill of gasoline from delivery truck	Potential failure of tank due to overheating of metal	Compressed gas is stored in classified area with LH <sub>2</sub> storage tank. NFPA 50B requires systems within 50 ft of above ground storage of flammable liquids to prevent accumulation of flammable liquids under the hydrogen system. Hydrogen system must also be at least 75 ft from the fill or vent line on any underground gasoline tanks.	L	H	Design and codes should consider stations dispensing both hydrogen and gasoline.
<p><b>Date:</b> July 10, 2003  <b>Process:</b> 1. Liquid Hydrogen  <b>Study Section:</b> 1D. Hydrogen Dispensing  <b>Design Intent:</b> Dispense up to 3 kg of hydrogen per vehicle at either 3,600 or 5,000 psig in 10 min</p>							
26	Piping failure	Vehicle impact to dispenser	Potential fire or explosion	Bollards around dispenser	L	H	
27	Dispenser cascade control failure	Pressure relief device on dispenser and storage tanks fails	Overpressure vehicle fuel tank Relief valve on vehicle tank vents		L	H	

No.	Failure Mode	Cause	Effects	Controls	F	C	Recommendation
28 ✂	Use wrong pressure nozzle (5,000 psig vs 3,600 psig)	Human error	Potential overpressure of vehicle fuel tank	Nozzles designed to prevent 5,000 psig nozzle to be attached to a 3,600 psig tank	L	M	
29	Drive away while connected to dispenser	Human error	Rupture hose and potential fire or explosion	Break away connection with poppet isolation valves	L	M	
30	Hose failure	Mechanical failure	Potential fire or explosion	Hoses rated for about 8,000 psig	L	M	Should be tested or inspected on a regular basis
31	Leak in connection	O-ring damaged or nozzle damaged	Potential fire	Dispenser conducts leak check prior to each fill.	M	L	
32	Vehicle pressure relief device leaks	Mechanical failure	Potential fire or explosion	Relief valve on vehicle tank vents.	L	M	
33	Fail to vent nozzle before disconnecting	Human error	<b>No safety hazard</b>	Venting before disconnecting is automatic, and is built into the nozzle.	-	-	
34	Fuel nozzle vent lever open while filling	Human error	Potential fire or explosion	Three-way valve is designed to only flow fuel when connected to vehicle. Foreign matter from dispenser could	L	M	
35	Nozzle leaks after disconnect	Mechanical failure	Potential fire	Dispenser valve closes	L	M	
36	Vehicle tank isolation valve leaks	Mechanical failure and leaking check valve	Potential fire		L	M	

Key parameters affecting safety include:

- Equipment located outdoors where hydrogen leaks would escape to the atmosphere
- Site layout and equipment meets NFPA 50A and NFPA 50B requirements
- Liquid hydrogen equipment is in a fenced area. Only trained personnel have access to the liquid hydrogen, compressor, and storage equipment.
- Liquid hydrogen storage, compressor, and dispenser in Class 1, Division 2 areas (Explosion proof equipment)
- Fuel dispenser uses CAFCP communication to fill protocol for temperature compensated vehicle filling. If vehicle is not equipped for communication fill, maximum fill pressure is 340 atm (5,000 psi).

### **Key Failure Modes**

Broadly, failure modes can be grouped into situations involving:

1. Exposure to spills and leaks of the cryogenic-liquid
2. Ignition of hydrogen gas from leaks and vaporization of spills
3. Mechanical failure of high pressure equipment

The FMEA team limited the analysis to failure modes considered both realistic and representative of the types of hazards that could occur at a fueling station. The team observed that risk scenarios involving asphyxiation hazards would also involve ignition hazards. Asphyxiation hazards were not analyzed because ignition hazards occur at a lower hydrogen concentration than asphyxiation hazards. The reader should be aware that the potential for asphyxiation hazards in enclosed spaces occur in situations where large volumes of liquid hydrogen are released. Intentional misuse, catastrophic environmental events, and vandalism were also not analyzed.

Cryogenic burns can occur during fuel unloading and facility operation. A fence and warning signs prevent public access to cryogenic equipment. Only trained personnel following appropriate safety protocols are permitted to access the cryogenic equipment.

Liquid hydrogen leaks and spills can occur at various points along the fueling-chain such as: damage to the liquid-hydrogen tanker truck delivering the hydrogen; damage to the liquid hydrogen transfer equipment such as hoses and fittings; overfilling of the on-site liquid hydrogen tank; failure of the on-site storage tank; and failure or malfunction of the associated components such as the cryogenic compressors/pumps, heat exchangers, valves, piping, and instrumentation. In addition to being a combustion hazard, the consequences of a liquid hydrogen leak/spill are severe cryogenic burns that may be caused to personnel who are working with the equipment.

Gaseous hydrogen leaks and venting also pose risks through the ignition of the hydrogen. Gaseous hydrogen leaks along the fueling system can occur due to: evaporation of liquid hydrogen from the leaks/spills described above; failure of the high-pressure compressor; damage to the high pressure storage tanks; damage to

dispensing equipment; damage to the piping and valves; and human errors such as vehicle drive-away with the dispensing hose still connected and careless behavior during refueling.

### **Failure Mode Ranking**

Table 3-5 categorizes all of the scenarios from the FMEA by combined frequency and consequence rating in a risk-binning matrix. This allows for identification of the prioritization of safety improvement efforts for the fueling system.

### **Liquid Hydrogen Delivery and Storage**

The FMEA team assigned a high (H) frequency risk rating to only one failure mode, which was the overfilling of the onsite liquid hydrogen storage tank (No. 5, Table 3-4). Filling the liquid level above the design capacity of the tank could result in a situation where the vapor in the tank condenses and the liquid expands beyond the tank capacity. Liquid hydrogen expands as heat enters the tank and pressure rises. Liquid hydrogen truck operators are trained in the proper procedures for filling stationary tanks to avoid an over fill situation; however, an H frequency was assigned to this scenario



**Table 3-5. Risk-Binning Matrix — Liquid Hydrogen Delivery, Compressed Gas Fueling**

Combined Risk: Consequence x Frequency		Frequency (F)		
		Low (L)	Medium (M)	High (H)
		Unlikely	Likely	Anticipated
Consequence (C)	High (H)	5	0	0
	Medium (M)	15	3	1
	Low (L) or Negligible (-)	4	4	0

Low or Negligible Risk

Moderate Risk

High Risk

because of the potential for human error. Implementing procedures to assure that the tank is not overfilled would reduce the risk associated with this scenario.

If this failure mode were to occur, it would result in the release of hydrogen from the pressure relief valves and in a fire if an ignition source were present. The FMEA team did not identify any controls that would prevent this failure mode from occurring in the first place and assigned a medium (M) risk rating to the consequence of this failure mode. Under the FMEA methodology followed here, the failure mode with the highest risk would have a risk assignment of HH (for F and C respectively) and the lowest would have an assignment of LL. For the liquid hydrogen station, the tank overfill attained the worst case status with a risk designation of HM.

Three failure modes associated with the failure of the liquid hydrogen storage tank, piping, and compressed gas tank received an H rating for the resulting consequences, since failures in liquid or gaseous storage tank could result in a fire or explosion. A low (L) risk of occurrence resulted in an HL rating. The quantity of gas stored in a liquid hydrogen tank (2,000 kg) represents much more fuel energy than the quantity of gas stored in compressed gas tanks. Consequently, the set back distances in NFPA 50B for liquid hydrogen are also greater than related distances in NFPA 50A for compressed

hydrogen. Tanks and storage vessels are protected with pressure relief devices, which help assure that the tank's maximum allowable pressure is not exceeded.

Several failure modes received MM ratings. Table 3-4 indicates recommendations for improving the risk ratings. For example, a collision of a car into a delivery truck that was unloading could result in a hydrogen leak (Failure Mode No. 2). The location of the truck unloading area, combined with the egress of automobile traffic to the site, is intended to minimize the potential for damage to the truck while unloading. Nonetheless, the FMEA team believes that the truck-unloading configuration indicated in the plot plan in Section 4 still allowed the potential for rare accidental collision. More improvements to the site plan or procedures to prevent automobiles from entering the fueling station site during fuel delivery would further reduce the risk.

Failure mode No. 8, also associated with the liquid hydrogen tank system, received an MM rating. As in Scenario No. 5, liquid hydrogen is released from the tank vent. A loss of vacuum in the liquid hydrogen tank can result in heat entering the tank and an expansion of the fuel.

### **Compression, Storage, Dispensing**

MM ratings were also assigned to scenarios in the fuel storage and vehicle dispensing sections of the fueling station. These scenarios apply to all of the fuel supply options. Both of these scenarios relate to an over pressure of the fuel tank and subsequent release of hydrogen from the pressure relief valve or vehicle pressure relief device. Under unusual weather conditions, the fueling station storage tanks can be filled while very cold and then heated during the day (No. 21, Table 3-4). The range in ambient temperature swings is taken into account in fueling station design; however, unusual temperature variations are possible. A failure in the instrumentation associated with the temperature compensation system could result in the overpressure of a vehicle tank during fueling (No. 27, Table 3-4).

The consequence ratings for the hydrogen compression system were all M or lower. For the liquid hydrogen system, the compressor is in the open and leaks would not have an opportunity to accumulate. This consequence rating was assigned because the equipment is located outdoors and leaking gas would rise away from the equipment and not accumulate.

The existing controls or lack of any controls greatly influenced the consequence risk rating for most failure modes. For example, in the cases where a hydrogen leak detector was present as a control, the resulting consequence risk level was mitigated to either an M or an L from an almost certain H in the absence of the control. The FMEA team observed that engineering design -- either equipment, system or civil/architectural design played an important role in the associated risk level. A simple example is the case of bollards protecting dispensing and piping equipment, which significantly lowers the frequency of catastrophic accidents from occurring.

Many of these top-level occurrences are a product of sub-events that individually may have had an H-rating but were undermined by associated lower risk sub-events. A single failure mode may be the result of a sequence of sub-events each of which has an associated frequency of occurrence. In such cases, the relative risk rating that was assigned by the FMEA team to the failure mode occurrence frequency was the sub-event frequency with the lowest risk rating.

Typically, this sub-event would prevent other sub-events with higher risk-ratings from materializing. For example, consider the scenario where a fire or explosion may occur due to a vehicle drive-away during dispensing (No. 29, Table 3-4). This scenario is unavoidable in all fueling station types because of the potential for human error. The drive-away on its own was considered to be a relatively high frequency (H) event. For ignition to occur under this failure mode, in addition to the drive-away, the break away connection has to fail and the hose must rupture, followed by failure of the poppet isolation valves. Finally, an ignition source must be present. At least two of the four sub-events to drive away were assigned a low (L) frequency of occurrence and hence the overall risk rating for the frequency of this failure mode occurring was assigned a low (L). The frequency of occurrence for many of the failure modes resulted with L and M designations by the FMEA team.

## **3.2 Electrolyzer Refueling Station FMEA**

### ***3.2.1 General Description***

The electrolyzer station for which an FMEA was performed has the following key components:

- Electrolysis unit (electrolyzer cell and power system)
- Pure water supply unit
- Alkalization unit
- High-pressure compressor
- High-pressure storage
- Dispenser

Section 4.2 presents a detailed description of a typical electrolyzer-based hydrogen refueling station.

### ***3.2.2 FMEA Results***

Table 3-6 lists the results of the FMEA evaluation. The FMEA evaluation followed the four major functions (supply, compression, storage, and delivery) required in a hydrogen fuel station. The hydrogen production process, which includes the introduction of a 34 percent KOH solution into the electrolysis cell, the production of hydrogen by

electrolysis of water, and the clean up of the hydrogen gas, is unique among the supply options in this report. After production, the purified hydrogen stream is sent to a compressor.

The pressurized (10 atm) electrolyzer selected for this study presents different safety challenges than those from an atmospheric system. The assumed system has the electrolyzer and compressor located in a ventilated enclosure. This strategy eliminates the requirement for some classified electrical equipment. A similar strategy was assumed for the SMR system. The storage and dispensing equipment is similar to the other fuel supply options.

Key parameters affecting safety include:

- Electrolyzer and compressor located in a ventilated enclosure with hydrogen detectors
- Site layout and equipment meets NFPA 50A
- Only trained personnel have access to the fuel production and compressor enclosure. Public access to the storage equipment is also prohibited.
- Storage tanks and dispenser in Class 1, Division 2 areas (Explosion proof equipment)
- Fuel dispenser uses CAFCP communication fill protocol for temperature compensated vehicle filling. If vehicle is not equipped for communication fill, maximum fill pressure is 345 atm (5,000 psi).

**Table 3-6. Electrolysis Station FMEA Results**

No.	Failure Mode	Cause	Effects	Controls	F	C	Recommendation
<b>Date:</b> July 8, 2003 <b>Process:</b> 2. Electrolysis <b>Study Section:</b> 2A. Water Electrolysis, Hydrogen Generation <b>Design Intent:</b> Generate 1.25 kg/h of >99.99% hydrogen at 150 psig by electrolysis of water							
1.	KOH leak	Mechanical failure or human error	Employee injury	Operator wears rubber gloves and face shield Safety shower and eyewash station in area Polycarbonate shield around cells	L	M	
2.	 Exposed electrical circuit 240 volts DC, 600 amps	Human error	Employee injury	Polycarbonate shield around cells limits access	L	H	
3.	Rectifier startup	Human error Turn unit on before turning breaker on and then contact rectifier	Employee injury		L	H	Provide mechanism to prevent turning power on to unit until rectifier breaker is on
4.	Demineralizer failure	Media is saturated or deactivated	Sludge buildup in bottom of cell, <b>no safety hazard</b>	Conductivity detector and high conductivity shutdown at one micro-Siemens	-	-	
5.	KOH pump failure	Mechanical failure	Low water level in cell and high temperature damages cell, <b>no safety hazard</b>	Low level shutdown High temperature shutdown	-	-	
6.	Cell control failure	Instrument failure leading to stack failure	Cell damage with loss of fluid and potential exposure	Low level shutdown High temperature shutdown	L	M	Provide caustic containment sump and drain

No.	Failure Mode	Cause	Effects	Controls	F	C	Recommendation
7.	Cell seal/demister failure	Mechanical failure	High oxygen level in electrolysis gas, generate high temperature in catalytic purifier and potential internal fire or explosion	Low level shutdown High temperature shutdown on oxygen header set at 70°C High differential temperature (>40C) across catalytic purifier Oxygen analyzer and shutdown on hydrogen line downstream of demister	L	H	
8.	Oxygen vent leak	Mechanical failure	Potential fire hazard (higher than normal oxygen content)	Oxygen must be vented to a safe location outdoors.	L	L	
9. ✂	Hydrogen gas leak	Mechanical failure and loss of blower	Potential fire or explosion	Enclosure is vented, at 20% LEL alarm, 40% shutdown Loss of blower shutdown	L	H	
10. ✂	Catalytic purifier failure	Fouling (may also need failure in cell to get high oxygen concentration)	High oxygen in product hydrogen, potential explosion in compressor	Oxygen analyzer and shutdown on hydrogen line downstream of demister (above 1% in 10 min, above 2% in 5 sec)	L	H	Provide oxygen analyzer downstream of purifier Evaluate upper flammable limit for hydrogen in pure oxygen
11.	Molecular sieve dryer failure	Mechanical failure, unable to regenerate	High moisture in hydrogen product, potential corrosion or hydrogen embrittlement of downstream equipment or water slug to compressor		M	L	Provide a dew point analyzer for hydrogen leaving dryers
12.	Venting electrolysis gas	Normal startup	Ignition of electrolysis vent	Gas is vented to a safe location.	L	L	
13.	Electrolysis gas vent valve leaks	Mechanical failure or human error	Air ingress to compressor and potential explosion or detonation (much more likely for low pressure systems)	Low pressure shutdown on compressor suction	L	H	
14.	Cooling system failure	Catalytic purifier aftercooler failure	Leak of hydrogen into cooling system and potential fire or explosion in surge tank	Gas is vented to a safe location	L	M	Provide LEL detector on cooling water surge tank vent. Vent must be in a safe location.

No.	Failure Mode	Cause	Effects	Controls	F	C	Recommendation
<b>Date:</b> July 8, 2003 <b>Process:</b> 2. Electrolysis <b>Study Section:</b> 2B. Hydrogen Compression <b>Design Intent:</b> Compress 1.25 kg/h of hydrogen from >80 psig to 6,250 psig							
15. ✂	Compressor suction line failure	Mechanical failure of line or fitting	Release of hydrogen and potential fire or explosion	Enclosure is vented, at 20% LEL alarm, 40% shutdown Loss of blower shutdown	L	H	Piping in the entire system should be designed to ASME B31.3 code.
16.	Cooling system failure	Loss of cooling fluid	Reduce piston life above 300°F <b>No safety hazard</b>		-	-	
17. ✂	Lubrication system failure	Loss of fluid	Compressor failure and hydrogen leak with potential fire or explosion	Enclosure is vented, at 20% LEL alarm, 40% shutdown Loss of blower shutdown Low oil pressure shutdown	L	H	
18. ✂	Seal failure	Mechanical failure	Release of hydrogen and potential fire or explosion	Enclosure is vented, at 20% LEL alarm, 40% shutdown Loss of blower shutdown Seal failure alarm on diaphragm compressor	L	H	
19.	Compressor suction or discharge valve failure	Mechanical failure	<b>No safety hazard</b>		-	-	
20.	Pressure relief device fails open	Mechanical failure	Relief valves are vented back to ballast or blow down tank <b>No safety hazard</b>		-	-	
21. ✂	Valve on discharge of compressor fails closed	Mechanical failure or human error and failure of pressure relief valve to open	Overpressure compressor and rupture line. Release of hydrogen and potential fire or explosion	Enclosure is vented, at 20% LEL alarm, 40% shutdown Loss of blower shutdown	L	H	
22. ✂	High pressure (6,250 psig) hydrogen supply line failure	Mechanical failure	Release of hydrogen and potential fire or explosion	Enclosure is vented, at 20% LEL alarm, 40% shutdown Loss of blower shutdown	L	H	Piping in the entire system should be designed to ASME B31.3 code.

No.	Failure Mode	Cause	Effects	Controls	F	C	Recommendation
<b>Date:</b> July 8, 2003 <b>Process:</b> 2. Electrolysis <b>Study Section:</b> 2C. Hydrogen Storage <b>Design Intent:</b> Store up to 78 kg of hydrogen at 6,250 psig							
23.	Overpressure and fail storage tank (MAWP 7,333 psig)	Fill storage tank on cold day to 6,250 psig Heat stored gas during day	Overpressure storage tank MAWP 7,333 psig, PRV releases hydrogen with potential fire or explosion	Maximum pressure due to thermal expansion is 7,290 psig based on 50°C increase in temp	M	M	Review climate conditions in safety plan
24.	Relief device failure (on cylinders) fails open	Mechanical failure	Release of hydrogen to atm via vent stack and potential fire or explosion	Vent stack is a minimum of 15 feet above grade	L	L	Storage system should contain redundant relief devices
25.	Storage tank failure	Mechanical failure, corrosion, hydrogen embrittlement	Release of hydrogen to atm and potential fire or explosion	Storage tank MAWP 7,333 psig	L	H	Storage system should contain redundant relief devices
26.	Piping leak	Mechanical failure	Release of hydrogen to atm and potential fire or explosion	NFPA 50A setback distances	L	H	
27.	Storage tank failure	External fire due to large spill of gasoline from delivery truck	Potential failure of tank due to overheating of metal	NFPA 50A requires systems within 50 ft of aboveground storage of flammable liquids to prevent accumulation of flammable liquids under the hydrogen system. Hydrogen system must also be at least 25 ft from the fill or vent line on any underground gasoline tanks	L	H	Design and codes should consider stations dispensing both hydrogen and gasoline
<b>Date:</b> July 8, 2003 <b>Process:</b> 2. Electrolysis <b>Study Section:</b> 2D. Hydrogen Dispensing <b>Design Intent:</b> Dispense up to 3 kg of hydrogen per vehicle at either 3,600 or 5,000 psig in 10 min							
28.	Piping failure	Vehicle impact to dispenser	Potential fire or explosion	Bollards around dispenser	L	H	



No.	Failure Mode	Cause	Effects	Controls	F	C	Recommendation
29.	Dispenser cascade control failure	Pressure relief device on dispenser and storage tanks fails	Overpressure vehicle fuel tank Relief valve on vehicle tank vents to roof of vehicle		L	H	
30.	 Use wrong pressure nozzle (5,000 psig vs 3,600 psig)	Human error	Potential overpressure of vehicle fuel tank	Nozzles designed to prevent 5,000 psig nozzle to be attached to a 3,600 psig tank	L	M	
31.	Drive away while connected to dispenser	Human error	Rupture hose and potential fire or explosion	Break away connection with poppet isolation valves	L	M	
32.	Hose failure	Mechanical failure	Potential fire or explosion	Hoses rated for about 8,000 psig	L	M	Should be tested or inspected on a regular basis
33.	Leak in connection	O-ring damaged or nozzle damaged	Potential fire	Dispenser conducts leak check prior to each fill	M	L	
34.	Vehicle pressure relief device leaks	Mechanical failure	Potential fire or explosion	Relief valve on vehicle tank vents	L	M	
35.	Fail to vent nozzle before disconnecting	Human error	No safety hazard	Venting before disconnecting is automatic, and is built into the nozzle	-	-	
36.	Vehicle tank backflows through dispenser vent.	Foreign matter in vehicle check valve (Gas backflows when 3-way valve turned to vent).	Potential fire or explosion	Ensure careful installation of piping to prevent introduction of foreign material.	L	M	
37.	Nozzle leaks after disconnect	Mechanical failure	Potential fire	Dispenser valve closes	L	M	
38.	Vehicle tank isolation valve leaks	Mechanical failure and leaking check valve	Potential fire		L	M	

## Key Failure Modes

Table 3-6 presents how the FMEA process was categorized into the major sections of the fueling station. Safety concerns for an electrolyzer based refueling station can arise from the associated high-voltage electrical systems, alkali (typically KOH) leaks, hydrogen leaks and the high-pressure systems. Further, in the system considered here, it was assumed that the hydrogen generation and compression units are installed in a large metal enclosure, somewhat similar in geometry to a truck-trailer container although smaller in scale. The presence of the enclosure generates additional complexities in terms of providing adequate ventilation and installation of flammable gas (hydrogen) detectors. The enclosure also houses the compressor equipment.

As noted above, Table 3-6 lists the key failure modes that were considered for the FMEA. A single failure mode may be the result of a sequence of sub-events each of which has an associated frequency of occurrence. In such cases, the FMEA team's relative risk rating to the failure mode occurrence frequency was the sub-event frequency with the lowest risk rating.

Typically this sub-event would prevent other sub-events with higher risk-ratings from materializing. For example, consider failure mode No. 9 in Table 3-6, which is an explosion from a hydrogen leak in the enclosure due to a mechanical failure of the equipment. While the consequence of such an explosion received a high (H) rank, the probability of occurrence of this failure mode received an overall low (L). To prevent the hydrogen gas from igniting, the system is designed to alarm if the hydrogen concentration in the enclosure reaches 20 percent of the LEL, and shutdown at a concentration of 40 percent of the LEL. In the event of a leak (with a probability of M-H), the blower fan prevents any significant concentrations of hydrogen from accumulating. The combination of the probability of the blower fan failing (M), the system shutdown failing (L), and finding an ignition source (L), received an overall probability of occurrence of low (L).

Still another example is the scenario where a fire or explosion may occur due to a vehicle drive-away during dispensing (No. 31, Table 3-6<sup>2</sup>). This is a scenario that is common to all fueling station types. The drive-away on its own was considered to be a relatively high frequency (H) event. For ignition to occur under this failure mode, in addition to the drive-away, the break away connection has to fail and the hose must rupture, followed by failure of the poppet isolation valves. Finally, an ignition source must be present. At least two of the four sub-events to drive away were assigned a low (L) frequency of occurrence and hence the overall risk rating for the frequency of this failure mode occurring was assigned a low (L). The frequency of occurrence for many of the failure modes resulted in L and M designations by the FMEA team.

<sup>2</sup> This example is repeated in each FMEA for readers who are interested in only one supply option.

## Failure Modes Ranking

Table 3-7 categorizes all of the scenarios from the FMEA by combined frequency and consequence rating in a risk binning matrix. This allows for the identification of the prioritization of safety improvement efforts for the fueling system.

**Table 3-7. Risk-Binning Matrix — Electrolysis Hydrogen Production, Compressed Gas Fueling**

Combined Risk: Consequence x Frequency		Frequency (F)		
		Low (L)	Medium (M)	High (H)
		Unlikely	Likely	Anticipated
Consequence (C)	High (H)	16	0	0
	Medium (M)	10	1	0
	Low (L) or Negligible (-)	3	2	0

Low or Negligible Risk

Moderate Risk

High Risk

## Hydrogen Production

As noted earlier, the failure modes in this FMEA focused on events that led to the ignition of the hydrogen gas. Potential harm could also be caused due to the electrical power system and the alkalization system. Based on the review of existing hydrogen equipment and the conceptual design information in Section 4, the FMEA team arrived at the consensus that existing controls and current practices of operation resulted in a low probability of occurrence for nearly all failure modes. As described above, a sequence of events must occur prior to ignition, and one or more of the sub-events have a low probability of occurrence. The highest probability of occurrence (M) was associated with the failure of the molecular sieve dryers for the purification of the product hydrogen (No. 11, Table 3-6); however, the FMEA team assigned the consequence of this failure mode as low (L).

## **Compression Storage, Dispensing**

The consequence risk rating for most failure modes was greatly influenced by the existing controls or lack of any controls, and whether the failure mode was associated with equipment inside or outside the enclosure. Typically, the team gave higher ratings to failure modes that occurred inside the enclosure. The FMEA team was also influenced by good engineering design practices in awarding risk ratings. A simple example is the case of bollards protecting dispensing and piping equipment, which significantly lower the frequency of catastrophic accidents from occurring.

Under the FMEA methodology being followed here, the failure mode with the highest risk would have a risk assignment of HH (for F and C, respectively), and the lowest would have an assignment of LL. Most failure modes received the LH designation, which can be considered as equivalent to the MM designation. Only one failure mode (No. 29, Table 3-6), involving the failure of the cascade dispenser control system, was assigned MM.

Hydrogen leaks in the production and compression enclosure received H consequence ratings (Nos. 9, 15, 17, 21, 22, Table 3-6); however, the combination of alarms and ventilation systems resulted in L frequency ratings for all of these scenarios. The consequences of a hydrogen ignition are higher than those in an open area, but the active controls reduce the possibility of any leak resulting in the formation of a flammable mixture.

The failure modes for storage and dispensing (2C and 2D) are the same as those for liquid hydrogen (1C and 1D). The compressed gas storage capacity for the electrolyzer system is larger than that for the liquid hydrogen or tube trailer systems because of the requirement to continuously store hydrogen produced during the day. This increase in storage capacity did not affect the FMEA ratings.

## **3.3 Steam Methane Reformer Refueling Station FMEA**

### ***3.3.1 General Description***

The FMEA performed for a steam methane reformer (SMR) station has the following key components:

- Natural gas desulfurization unit
- Steam Methane Reformer
- Pure water supply unit
- Purification Unit (pressure swing absorption)
- High-pressure compressor
- High-pressure storage
- Dispenser

Section 4.3 presents a detailed description of a typical SMR-based hydrogen refueling station.

### **3.3.2 FMEA Results**

Table 3-8 presents the results of the FMEA. The FMEA process followed the four major areas in the fueling station. The natural gas desulfurization, steam methane reformer, and gas clean-up (Section 3A) are unique among the supply options in this report. Natural gas and steam are reacted in the reformer at 10 atm. The product gas is processed by the PSA and the pure hydrogen is fed into a compressor. The 10 atm steam reformer assumed in this study presents different safety challenges than an atmospheric system. All components of this SMR-based station except the dispenser are located in a ventilated enclosure. This strategy eliminates the requirement for some classified electrical equipment. A similar strategy was assumed for the electrolyzer system. The storage and dispensing equipment is similar to the other fuel supply options.

Key parameters affecting safety include:

- SMR and compressor located in a ventilated enclosure with hydrogen detectors
- Site layout and equipment meets NFPA 50A
- Only trained personnel have access to the fuel production and compressor enclosure. Public access to the storage equipment is also prohibited.
- Storage tanks and dispenser in Class 1, Division 2 areas (Explosion proof equipment)
- Fuel dispenser uses CAFCP communication fill protocol for temperature compensated vehicle filling. If vehicle is not equipped for communication fill, maximum fill pressure is 340 atm (5,000 psi).

### **Key Failure Modes**

Table 3-8 categorizes all of scenarios from the FMEA by combined frequency and consequence rating. This risk binning allows for the identification of the prioritization of safety improvement efforts for the fueling system. Table 3-8 presents how the FMEA process was categorized into the major functions (supply, compression, storage, and delivery) required in a hydrogen fuel station. Broadly stated, the safety concerns for the steam methane reformer based hydrogen supply system can arise from the high pressure reactor, the PSA system, hydrogen leaks, and the proximity of ignition sources (SMR burners).



**Table 3-8. SMR Station FMEA Results**

No.	Failure Mode	Cause	Effects	Controls	F	C	Recommendation
<b>Date:</b> July 10, 2003 <b>Process:</b> 3. SMR <b>Study Section:</b> 3A. Natural Gas Steam Reforming, Hydrogen Purification <b>Design Intent:</b> Generate 1.25 kg/h of >99.99% hydrogen at 150 psig from reforming of natural gas							
1.	Natural gas line leak downstream of compressor	Mechanical failure	Potential fire/explosion	Combustible gas detector inside enclosure and enclosure is ventilated	L	H	
2.	Natural gas compressor high discharge pressure	Instrument failure, pressure relief valve (PRV) fails to open (set at 150 psig)	Overpressure reformer (design pressure 150 psig)	Pressure relief device vented to atmospheric stack downstream, also pressure relief valve and rupture disc on reformer	L	H	
3.	Desulfurizer failure	Media is saturated or deactivated	Unable to remove odorant or hydrogen sulfide, poison reformer and shift catalyst and unable to make sufficient hydrogen, increase in purge gas flow to reformer and potential high temperature	High temperature shutdown on reformer	L	H	Provide odorant detector downstream of desulfurizer
4.	Desulfurizer failure	High level of mercaptans or high natural gas flow	Unable to remove heat of adsorption and potential fire in carbon bed		L	H	Include heat release analysis from sulfur removal equipment in design review
5.	Deionized water pump failure	Mechanical failure	No steam for reforming of natural gas, coke reformer tubes, potential tube failure	Low water flow and high temperature shutdowns	L	M	
6.	Water quality failure	Deionization system failure	Plug heat exchanger tubes, potential tube failure	Conductivity analyzer	L	L	
7.	Air blower failure	Mechanical failure	Loss of flame and potential explosion	Flame safety shutdown on loss of flame and low temperature requires purge before restart	L	H	

No.	Failure Mode	Cause	Effects	Controls	F	C	Recommendation
8.	Natural gas feed valve leaks	Mechanical failure	Potential explosion in reformer on light-off	Mandatory purge before light-off	L	H	
9.	Reformer flame failure	Natural gas pressure swing or condensate	Potential explosion in reformer upon re-ignition	Flame safety shutdown on loss of flame and low temperature requires purge before restart	L	H	
10.	Reformer temperature or combustion control failure	Instrument failure causes ratio of natural gas to steam to be too high	Damage tubes, reformer catalyst, exceed CO/CO <sub>2</sub> capacity of PSA unit	High temperature shutdown on reformer	L	H	
11.	Overpressure reformer (design pressure 150 psig)	PSA feed control valve closed	Fail reformer tube	Pressure relief device vented to atmospheric stack downstream, also pressure relief valve and rupture disc on reformer	L	H	
12.	Waste heat recovery water exchanger failure	Mechanical failure	Water spills into exhaust stack <b>No safety hazard</b>		–	–	
13.	Waste heat recovery natural gas exchanger failure	Mechanical failure	Natural gas leaks into exhaust stack and ignites	High stack temperature and CO shutdown	L	M	
14.	Hydrogen gas leak into enclosure	Mechanical failure of process gas cooler, valves and other potential leak points	Process gas flow into enclosure, potential fire or explosion	Combustible gas detector inside enclosure and enclosure is ventilated	L	H	
15.	Condensate separator control valve fails open	Mechanical failure	Process gas into condensate disposal system and potential fire or explosion Condensate is recycled		M	M	Condensate surge tank vent should be vented to stack
16.	Condensate separator control valve fails closed	Instrument failure	Slug of condensate in the hydrogen feed to PSA unit Product quality issue <b>No safety hazard</b>	Water traps in line to PSA unit	–	–	

No.	Failure Mode	Cause	Effects	Controls	F	C	Recommendation
17.	Shift reactor failure	Hot spot due to methanation reaction	Release of process gas	Combustible gas detector inside enclosure and enclosure is ventilated High temperature shutdown	L	H	
18.	PSA unit failure	Adsorbent failure due to age	Unable to purify hydrogen and damage vehicle fuel cell <b>No safety hazard</b>		–	–	Verify if product gas from PSA unit is analyzed
19.	PSA control failure during regen	Leak hydrogen to reformer	Increase temperature in reformer	High temperature shutdown	L	H	
20.	Leak in PSA waste gas line	Mechanical failure	Release of CO and hydrogen, potential toxic exposure to CO and potential fire or explosion	CO monitor in enclosure exhaust	L	M	

**Date:** July 10, 2003  
**Process:** 3. SMR  
**Study Section:** 3B. Hydrogen Compression  
**Design Intent:** Compress 1.25 kg/h of hydrogen from 150 psig to 6,250 psig

21.	 Compressor suction line failure	Mechanical failure of line or fitting	Release of hydrogen and potential fire or explosion	Enclosure is vented, at 20% LEL alarm, 40% shutdown Loss of blower shutdown	L	H	Piping in the entire system should be designed to ASME B31.3 code
22.	Cooling system failure	Loss of cooling fluid	Reduce piston life above 300°F <b>No safety hazard</b>		–	–	
23.	 Lubrication system failure	Loss of fluid	Compressor failure and hydrogen leak with potential fire or explosion	Enclosure is vented, at 20% LEL alarm, 40% shutdown Loss of blower shutdown Low oil pressure shutdown	L	H	
24.	 Seal failure	Mechanical failure	Release of hydrogen and potential fire or explosion	Enclosure is vented, at 20% LEL alarm, 40% shutdown Loss of blower shutdown Seal failure alarm on diaphragm compressor	L	H	



No.	Failure Mode	Cause	Effects	Controls	F	C	Recommendation
25.	Compressor suction or discharge valve failure	Mechanical failure	<b>No safety hazard</b>		-	-	
26.	Pressure relief device fails open	Mechanical failure	Relief valves are vented back to ballast or blow down tank <b>No safety hazard</b>		-	-	
27.	Valve on discharge of compressor fails closed	Mechanical failure or human error and failure of pressure relief valve to open	Overpressure compressor and rupture line. Release of hydrogen and potential fire or explosion	Enclosure is vented, at 20% LEL alarm, 40% shutdown Loss of blower shutdown	L	H	
28.	High pressure (6,250 psig) hydrogen supply line failure	Mechanical failure	Release of hydrogen and potential fire or explosion	Enclosure is vented, at 20% LEL alarm, 40% shutdown Loss of blower shutdown	L	H	

**Date:** July 10, 2003  
**Process:** 3. SMR  
**Study Section:** 3C. Hydrogen Storage  
**Design Intent:** Store up to 4 kg of hydrogen at 6,250 psig

29.	 Fill storage tank on cold day to 6,250 psig	Fill storage tank on cold day to 6,250 psig Heat stored gas during day	Overpressure storage tank MAWP 7,333 psig, PRV releases hydrogen with potential fire or explosion	Maximum pressure due to thermal expansion is 7,290 psig based on 50°C increase in temp	M	M	Review climate conditions in safety plan
30.	Relief device failure (on cylinders) fails open	Mechanical failure	Release of hydrogen to atm via vent stack and potential fire or explosion	Vent stack is a minimum of 15 feet above grade	L	L	
31.	Storage tank failure	Mechanical failure, corrosion, hydrogen embrittlement	Release of hydrogen to atm and potential fire or explosion	Storage tank MAWP 7,333 psig	L	H	Storage system should contain redundant relief devices
32.	Piping leak	Mechanical failure	Release of hydrogen to atm and potential fire or explosion	NFPA 50A setback distances	L	H	

No.	Failure Mode	Cause	Effects	Controls	F	C	Recommendation
33.	Storage tank failure	External fire due to large spill of gasoline from delivery truck	Potential failure of tank due to overheating of metal	NFPA 50A requires systems within 50 ft of aboveground storage of flammable liquids to prevent accumulation of flammable liquids under the hydrogen system. Hydrogen system must also be at least 25 ft from the fill or vent line on any underground gasoline tanks	L	H	Design and codes should consider stations dispensing both hydrogen and gasoline
<b>Date:</b> July 10, 2003 <b>Process:</b> 3. SMR <b>Study Section:</b> 3D. Hydrogen Dispensing <b>Design Intent:</b> Dispense up to 3 kg of hydrogen per vehicle at either 3,600 or 5,000 psig in 10 min							
34.	Piping failure	Vehicle impact to dispenser	Potential fire or explosion	Bollards around dispenser	L	H	
35.	Dispenser cascade control failure	Pressure relief device on dispenser and storage tanks fails	Overpressure vehicle fuel tank Relief valve on vehicle tank vents.		L	H	
36.	Use wrong pressure nozzle (5,000 psig vs. 3,600 psig)	Human error	Potential overpressure of vehicle fuel tank	Nozzles designed to prevent 5,000 psig nozzle to be attached to a 3,600 psig tank	L	M	
37.	Drive away while connected to dispenser	Human error	Rupture hose and potential fire or explosion	Break away connection with poppet isolation valves	L	M	
38.	Hose failure	Mechanical failure	Potential fire or explosion	Hoses rated for about 8,000 psig	L	M	Should be tested or inspected on a regular basis
39.	Leak in connection	O-ring damaged or nozzle damaged	Potential fire	Dispenser conducts leak check prior to each fill	M	L	
40.	Vehicle pressure relief device leaks	Mechanical failure	Potential fire or explosion	Relief valve on vehicle tank vents	L	M	

No.	Failure Mode	Cause	Effects	Controls	F	C	Recommendation
41.	Fail to vent nozzle before disconnecting	Human error	No safety hazard	Venting before disconnecting is automatic, and is built into the nozzle	-	-	
42.	Vehicle tank back-flows through dispenser vent.	Foreign matter in vehicle check valve (Gas backflows when 3-way valve turned to vent).	Potential fire or explosion	Ensure careful installation of piping to prevent introduction of foreign material.	L	M	
43.	Nozzle leaks after disconnect	Mechanical failure	Potential fire	Dispenser valve closes	L	M	
44.	Vehicle tank isolation valve leaks	Mechanical failure	Potential fire or explosion		L	M	

Table 3-8 lists the key failure modes that were considered for the FMEA. A single failure mode may be the result of a sequence of sub-events, each of which has an associated frequency of occurrence. In such cases, the relative risk rating that was assigned by the FMEA team to the failure mode occurrence frequency was the sub-event frequency with the lowest risk rating. Typically, this sub-event would prevent other sub-events with higher risk-ratings from materializing. For example, consider failure mode No. 9 in Table 3-8, which is an explosion that results from relighting the reformer after a flame-out. While the probability of flame failure occurrence is high (H), the overall frequency of an explosion occurring received an L ranking as the flame safety shutdown procedure on loss of flame and low temperature requires purge before restart.

### Failure Modes Ranking

Table 3-9 categorizes all scenarios from the FMEA by combined frequency and consequence rating in the risk binning matrix. This allows for the identification of the prioritization of safety improvement efforts for the fueling system.

**Table 3-9. Risk-Binning Matrix — SMR Hydrogen Production, Compressed Gas Fueling**

Combined Risk: Consequence x Frequency		Frequency (F)			Low or Negligible Risk
		Low (L)	Medium (M)	High (H)	
		Unlikely	Likely	Anticipated	
Consequence (C)	High (H)	22	0	0	Moderate Risk
	Medium (M)	10	2	0	High Risk
	Low (L) or Negligible (-)	2	1	0	

## Hydrogen Production

As seen in the risk binning matrix in Table 3-9, 24 (55 percent) of the failure modes present a moderate risk. As noted previously, the FMEA team took into consideration good engineering design as well as practices. In the hydrogen production and purification system, the item with highest risk received a ranking of MM and involved the improper venting of a surge tank in the hydrogen process line (No. 15, Table 3-8). The FMEA team also identified that this failure mode could be mitigated with some minor design changes.

## Compression, Storage, Dispensing

The results for this section are similar to other fueling stations and are repeated for completeness. MM ratings were also assigned to scenarios in the fuel storage and vehicle dispensing sections of the fueling station. These scenarios apply to all of the fuel supply options. Both of these scenarios relate to an over pressure of the fuel tank and subsequent release of hydrogen from the pressure relief valve or vehicle pressure relief device. Under unusual weather conditions, the fueling station storage tanks can be filled while very cold and then heated during the day. The range in ambient temperature swings is taken into account in fueling station design; however, unusual temperature variations are possible. A failure in the instrumentation associated with the temperature compensation system could result in the overpressure of a vehicle tank during fueling. The consequence ratings for the hydrogen compression system were all M or lower. For the liquid hydrogen system, the compressor is in the open and leaks would not have an opportunity to accumulate.

The consequence risk rating for most failure modes was greatly influenced by the existing controls or lack of any controls. For example, in the cases where a hydrogen leak detector was present as a control, the resulting consequence risk level was mitigated to either an M or an L from an almost certain H in the absence of the control. The FMEA team observed that engineering design — equipment, system or civil/architectural design — played an important role in the associated risk level. A simple example is the case of bollards protecting dispensing and piping equipment, which significantly lowers the frequency of catastrophic accidents from occurring.

Many of these top-level occurrences are a product of sub-events that individually may have had an H-rating but were reduced by associated lower risk sub-events. A single failure mode may be the result of a sequence of sub-events each of which has an associated frequency of occurrence. In such cases, the relative risk rating that was assigned by the FMEA team to the failure mode occurrence frequency was the sub-event frequency with the lowest risk rating. Typically this sub-event would prevent other sub-events with higher risk-ratings from materializing. For example, consider the scenario where a fire or an explosion may occur due to a vehicle drive-away during

dispensing (Item No. 37, Table 3-8)<sup>3</sup>. This scenario is unavoidable in all fueling station types because of the potential for human error. The drive-away on its own was considered to be a relatively high frequency (H) event. However, for ignition to occur under this failure mode, in addition to the drive-away, the break away connection has to fail and the hose must rupture, followed by failure of the poppet isolation valves. Finally, an ignition source must be present. At least two of the four sub-events to drive away were assigned a low (L) frequency of occurrence, and hence the overall risk rating for the frequency of this failure mode occurring was assigned a low (L). The frequency of occurrence for many of the failure modes resulted with L and M designations by the FMEA team.

## **3.4 Tube Trailer Compressed Hydrogen Refueling Station FMEA**

### ***3.4.1 General Description***

The tube trailer based compressed hydrogen refueling station for which an FMEA was performed has the following key components:

- Nominally 210 atm (3,100 psig) hydrogen gas tube trailer storage
- High-pressure compressor
- High-pressure storage
- Dispenser

### ***3.4.2 FMEA Results***

Table 3-10 presents the results of the FMEA. The FMEA process followed the major functions (supply, compression, storage, and delivery) required in a hydrogen fueling station. The features unique to the tube trailer station are the tube trailer storage and transfer of tubes by the hydrogen supplier. The high-pressure compression, storage, and dispensing equipment are similar for the other fuel supply options.



Key parameters affecting safety include:

- Tube trailer transfer and storage
- Site layout and equipment meets NFPA 50A
- Only trained personnel have access to the fuel transfer equipment. Public access to the storage equipment is also prohibited.

<sup>3</sup> This example is repeated in each FMEA for readers who are interested in only one supply option.

**Table 3-10. Tube Trailer Hydrogen Station FMEA Results**

No.	Failure Mode	Cause	Effects	Controls	F	C	Recommendation
<b>Date:</b> July 10, 2003 <b>Process:</b> 4. Compressed Hydrogen <b>Study Section:</b> 4A. Hydrogen Tube Trailer Delivery <b>Design Intent:</b> Unload and store 343 kg of hydrogen at 3,130 psig from a tube trailer							
1.	Compressed trailer leak	Mechanical failure due to road vibration	Potential fire	Unloading inspection by station rep or driver Hydrogen leak detectors in area	M	L	
2.	Compressed trailer leak	Vehicle impact to trailer while at unloading spot damages hydrogen piping	Potential fire/explosion	Tube trailer parked behind fence	L	M	Need additional staging area to replace tube trailer
3.	Compressed trailer leak	Vehicle impact to trailer while in staging area damages hydrogen piping	Potential fire/explosion	Driver puts caution cones around truck	M	M	Establish separation distance of vehicles from unloading truck
4.	Compressed trailer leak	Trailer impacts bollard or other structure during change out	Potential fire/explosion	Driver training	M	M	Need sufficient staging area to promote safe changeout of trailers
5.	Hose connection leaks during detachment or attachment	Mechanical failure or improper connection, improper venting before disconnect or leak when making new connection	Potential fire	Unloading is continuously monitored by both driver and station rep. Driver training and unloading checklist, using standard established procedures for unloading hydrogen	M	L	Implement a leak check when making connection to new trailer

No.	Failure Mode	Cause	Effects	Controls	F	C	Recommendation
6.	Tube trailer failure	External fire due to large spill of gasoline from delivery truck	Potential failure of tank due to overheating of metal	NFPA 50A requires systems within 50 ft of aboveground storage of flammable liquids to prevent accumulation of flammable liquids under the hydrogen system. Hydrogen system must also be at least 25 ft from the fill or vent line on any underground gasoline tanks	L	H	Design and codes should consider stations dispensing both hydrogen and gasoline
7.	Failure of pressure relief device open	Mechanical failure	Release of hydrogen to atmosphere and potential fire or explosion	Relief devices are vented through a stack on the trailer	M	L	
8.	Failure of tube on trailer	Mechanical failure	Release of hydrogen to atmosphere and potential fire or explosion		L	H	
<b>Date:</b> July 10, 2003 <b>Process:</b> 4. Compressed hydrogen <b>Study Section:</b> 4B. Hydrogen Compression <b>Design Intent:</b> Compress 1.25 kg/h of hydrogen from 200 psig to 6,250 psig							
9.	Pressure reducing valve fails open	Mechanical failure	Overpressure compressor or downstream piping and release of hydrogen and potential fire and projectiles	High and low pressure limit switch on compressor Pressure relief valve on compressor discharge	L	H	
10.	 Compressor suction line failure	Mechanical failure of line or fitting	Release of hydrogen and potential fire	Hydrogen detectors, area electrical classification	L	M	Piping in the entire system should be designed to ASME B31.3 code
11.	Cooling system failure	Loss of cooling fluid	Reduce piston life above 300°F <b>No safety hazard</b>		-	-	
12.	 Lubrication system failure	Loss of fluid	Compressor failure and hydrogen leak with potential fire	Hydrogen detectors, area electrical classification Low oil pressure shutdown	L	M	



No.	Failure Mode	Cause	Effects	Controls	F	C	Recommendation
13. ✂	Seal failure	Mechanical failure	Release of hydrogen and potential fire	Seal failure alarm on compressor	L	M	
14.	Compressor suction or discharge valve failure	Mechanical failure	<b>No safety hazard</b>		-	-	
15.	Pressure relief device fails open	Mechanical failure	Relief valves are vented to vent stack <b>No safety hazard</b>		-	-	
16. ✂	Valve on discharge of compressor fails closed	Mechanical failure or human error and failure of pressure relief valve to open	Overpressure compressor and rupture line. Release of hydrogen and potential fire or explosion	Hydrogen detectors, area electrical classification	L	M	
17. ✂	High pressure (6,250 psig) hydrogen supply line failure	Mechanical failure	Release of hydrogen and potential fire or explosion	Hydrogen detectors, area electrical classification	L	M	
<b>Date:</b> July 10, 2003 <b>Process:</b> 4. Compressed Hydrogen Tube Trailer <b>Study Section:</b> 4C. Hydrogen Storage <b>Design Intent:</b> Store up to 30 kg of hydrogen at 6,250 psig							
18.	Fill storage tank on cold day to 6,250 psig	Fill storage tank on cold day to 6,250 psig Heat stored gas during day	Overpressure storage tank MAWP 7,333 psig, PRV releases hydrogen with potential fire or explosion	Maximum pressure due to thermal expansion is 7,290 psig based on 50°C increase in temp	M	M	Review climate conditions in safety plan
19.	Relief device failure (on cylinders) fails open	Mechanical failure	Release of hydrogen to atm via vent stack and potential fire or explosion	Vent stack is a minimum of 15 feet above grade	L	L	Storage system should contain redundant relief devices
20.	Storage tank failure	Mechanical failure, corrosion, hydrogen embrittlement	Release of hydrogen to atm and potential fire or explosion	Storage tank MAWP 7,333 psig	L	H	Storage system should contain redundant relief devices
21.	Piping leak	Mechanical failure	Release of hydrogen to atm and potential fire or explosion	NFPA 50A setback distances	L	H	

No.	Failure Mode	Cause	Effects	Controls	F	C	Recommendation
22.	Storage tank failure	External fire due to large spill of gasoline from delivery truck	Potential failure of tank due to overheating of metal	NFPA 50A requires systems within 50 ft of aboveground storage of flammable liquids to prevent accumulation of flammable liquids under the hydrogen system. Hydrogen system must also be at least 25 ft from the fill or vent line on any underground gasoline tanks	L	H	Design and codes should consider stations dispensing both hydrogen and gasoline
<b>Date:</b> July 10, 2003 <b>Process:</b> 4. Compressed Hydrogen <b>Study Section:</b> 4D. Hydrogen Dispensing <b>Design Intent:</b> Dispense up to 3 kg of hydrogen per vehicle at either 3,600 or 5,000 psig in 10 min							
23.	Piping failure	Vehicle impact to dispenser	Potential fire or explosion	Bollards around dispenser	L	H	
24.	Dispenser cascade control failure	Pressure relief device on dispenser and storage tanks fails	Overpressure vehicle fuel tank Relief valve on vehicle tank		L	H	
25.	Use wrong pressure nozzle (5,000 psig vs 3,600 psig)	Human error	Potential overpressure of vehicle fuel tank	Nozzles designed to prevent 5,000 psig nozzle to be attached to a 3,600 psig tank	L	M	
26.	Drive away while connected to dispenser	Human error	Rupture hose and potential fire or explosion	Break away connection with poppet isolation valves	L	M	
27.	Hose failure	Mechanical failure	Potential fire or explosion	Hoses rated for about 8,000 psig	L	M	Should be tested or inspected on a regular basis
28.	Leak in connection	O-ring damaged or nozzle damaged	Potential fire	Dispenser conducts leak check prior to each fill	M	L	
29.	Vehicle pressure relief device leaks	Mechanical failure	Potential fire or explosion	Relief valve on vehicle tank vents to roof of vehicle	L	M	

No.	Failure Mode	Cause	Effects	Controls	F	C	Recommendation
30.	Fail to vent nozzle before disconnecting	Human error	No safety hazard	Venting before disconnecting is automatic, and is built into the nozzle	-	-	
31.	Vehicle tank back-flows through dispenser vent.	Foreign matter in vehicle check valve (Gas backflows when 3-way valve turned to vent).	Potential fire or explosion	Ensure careful installation of piping to prevent introduction of foreign material.		M	
32.	Nozzle leaks after disconnect	Mechanical failure	Potential fire	Dispenser valve closes	L	M	
33.	Vehicle tank isolation valve leaks	Mechanical failure and leaking check valve	Potential fire		L	M	
34.	Piping failure	Vehicle impact to dispenser	Potential fire or explosion	Bollards around dispenser	L	H	
35.	Dispenser cascade control failure	Instrument failure	Overpressure vehicle fuel tank Relief valve on vehicle tank vents to roof of vehicle		M	M	Limit maximum possible exposure of the vehicle tank to 1.25 x MAWP through appropriate piping of the cascade system. Install pressure relief device on dispenser to protect against vehicle overpressure.

- Storage tanks and dispenser in Class 1, Division 2 areas (Explosion proof equipment)
- Fuel dispenser uses CAFCP communication fill protocol for temperature compensated vehicle filling. If vehicle is not equipped for communication fill, maximum fill pressure is 340 atm (5,000 psi).

## **Key Failure Modes**

Table 3-10 presents how the FMEA process was categorized into the major functions (supply, compression, storage, and delivery) required in a hydrogen fueling station. Broadly stated, safety concerns for the tube trailer station stem from possible hydrogen leaks and the high-pressure system. As noted above, Table 3-10 lists the key failure modes that were considered for the FMEA. As in the case of other types of hydrogen fueling stations, a single failure mode may be the result of a sequence of sub-events, each of which has an associated frequency of occurrence.

In such cases, the relative risk rating assigned by the FMEA team to the failure mode occurrence frequency was the sub-event frequency with the lowest risk rating. Typically, this sub-event would prevent other sub-events with higher risk-ratings from materializing. For example, consider failure mode No. 6 in Table 3-10, which is an explosion from the potential failure of the tubes due to a large gasoline spill in the vicinity. While the consequence of such an explosion received a high (H) rank, the probability of occurrence of this failure mode received an overall low (L) rank. To prevent the explosion from occurring, the tubes will be vented using pressure relief devices in the event of an over pressure. Further, code-related set back distances for equipment placement and fuel transfer mitigated some of the H level risks to L level.

## **Failure Mode Ranking**

Table 3-11 categorizes all of scenarios from the FMEA by combined frequency and consequence rating. This risk binning allows for the overall identification of the prioritization of safety improvement efforts for the fueling system.

## **Hydrogen Delivery and Storage**

The highest risk levels assigned by the FMEA team was MM to failure modes number 3 and 4 in Table 3-10. Both result from a fracturing impact to the tube trailer. The FMEA team also identified further steps that would mitigate this risk to lower levels. The mitigation steps included establishing adequate separation distances and staging areas for tube transfer that would minimize accidental vehicle/trailer impact.

Several scenarios received LM ratings. Table 3-10 indicates recommendations for improving the risk ratings.

**Table 3-11. Risk-Binning Matrix — Tube Trailer Delivery, Compressed Gas Fueling**

Combined Risk: Consequence x Frequency		Frequency (F)			Low or Negligible Risk
		Low (L)	Medium (M)	High (H)	
		Unlikely	Likely	Anticipated	
Consequence (C)	High (H)	9	0	0	Moderate Risk
	Medium (M)	13	4	0	
	Low (L) or Negligible (-)	1	4	0	

**Compression, Storage, Dispensing**

High pressure compression, storage, and dispensing is similar in design and function to the other fueling stations considered here. MM ratings were also assigned to scenarios in the fuel storage and vehicle dispensing sections of the fueling station. These scenarios apply to all of the fuel supply options. Both scenarios relate to an over pressure of the fuel tank and subsequent release of hydrogen from the pressure relief valve or vehicle pressure relief device. Under unusual weather conditions, the fueling station storage tanks can be filled while cold and then heated throughout the day. The range in ambient temperature swings is taken into account in fueling station design; however, unusual temperature variations are possible. A failure in the instrumentation associated with the temperature compensation system could result in the overpressure of a vehicle tank during fueling.

The consequence risk rating for most failure modes was greatly influenced by the existing controls or lack of any controls. For example, in the cases where a hydrogen leak detector was present as a control, the resulting consequence risk level was mitigated to either an M or an L from an almost certain H in the absence of the control. The FMEA team observed that engineering design — equipment, system or

civil/architectural design — played an important role in the associated risk level. A simple example is bollards protecting dispensing and piping equipment, which significantly lower the frequency of catastrophic accidents from occurring.

Many top-level occurrences are a product of sub-events that individually may have an H-rating but were reduced by associated lower risk sub-events. A single failure mode may be the result of a sequence of sub-events, each of which has an associated frequency of occurrence. In such cases, the relative risk rating that was assigned by the FMEA team to the failure mode occurrence frequency was the sub-event frequency with the lowest risk rating. Typically this sub-event would prevent other sub-events with higher risk-ratings from materializing. For example, consider the scenario where a fire or explosion may occur due to a vehicle drive-away during dispensing (No. 27, Table 3-10<sup>4</sup>). This scenario is unavoidable in all fueling station types because of the potential for human error.

The drive-away on its own was considered to be a relatively high frequency (H) event; however, for ignition to occur under this failure mode, in addition to the drive-away the break away connection has to fail and the hose must rupture, followed by failure of the poppet isolation valves. Finally, an ignition source must be present. At least two of the four sub-events to drive away were assigned a low (L) frequency of occurrence and hence the overall risk rating for the frequency of this failure mode occurring was assigned low (L). The FMEA team designated L and M as the frequency of occurrence for many of the failure modes.

## **3.5 CNG Refueling Station FMEA**

### ***3.5.1 General Description***

The compressed natural gas (CNG) refueling station for which an FMEA was performed has the following key components

- High-pressure compressor
- High-pressure storage
- Dispenser

Section 4.5 presents a detailed description of a typical CNG-based refueling station.

<sup>4</sup> This example is repeated in each FMEA for readers who are interested in only one supply option.

### **3.5.2 FMEA Results**

Table 3-12 presents the results of the FMEA. The FMEA process followed the four major areas in the fueling station. The typical CNG station is supplied natural gas directly by the city-gas lines and this is where it differs from the hydrogen stations described previously. Once the station receives the fuel, the remaining major steps such as high pressure compression, storage, and dispensing are in concept similar to the hydrogen refueling stations described earlier.

Key parameters affecting safety include:

- Natural gas delivery
- Site layout and equipment meets NFPA 52
- Public access to the compression and storage equipment is also prohibited.
- Storage tanks and dispenser in Class 1, Division 2 areas (Explosion proof equipment)

#### **Key Failure Modes**

Table 3-12 presents how the FMEA process was categorized into the major functions (supply, compression, storage, and delivery) required in a fueling station. Broadly stated, safety concerns for a CNG station stem from natural gas leaks and associated high-pressure systems. As noted above, Table 3-12 lists the key failure modes that were considered for the FMEA. As in the case of the other types of fueling stations presented in this report, a single failure mode may be the result of a sequence of sub-events each of which has an associated frequency of occurrence. In such cases, the relative risk rating that was assigned by the FMEA team to the failure mode occurrence frequency was the sub-event frequency with the lowest risk rating. Typically this sub-event would prevent other sub-events with higher risk-ratings from materializing. For example, consider failure mode No. 6 in Table 3-12, which is an explosion or fire from the potential failure of the compressor seals. While the consequence of such an explosion received a high (H) rank, the frequency of occurrence of this failure mode received an overall low (L). Even if the frequency of a seal failure is higher than L, the failure mode in No. 6 is mitigated by the frequency of an ignition occurring, since both a failure of the detectors as well as presence of an ignition source must occur.

#### **Failure Mode Ranking**



Table 3-13 categorizes all 26 scenarios from the FMEA by combined frequency and consequence rating. This risk binning allows for the overall identification of the prioritization of safety improvement efforts for the fueling system.

**Table 3-12. CNG Station FMEA Results**

No.	Failure Mode	Cause	Effects	Controls	F	C	Recommendation
<b>Date:</b> July 10, 2003 <b>Process:</b> 5. CNG <b>Study Section:</b> 5A. Natural gas delivery <b>Design Intent:</b> Receive and dry pipeline natural gas at 6810 SCFD							
1.	Natural gas line leak	Mechanical failure	Potential fire/explosion	Gas is odorized Combustible gas detectors	L	H	
2.	 Natural gas dryer failure	Adsorbent saturated	Unable to remove moisture from gas and potential icing in vehicle Corrosion and/or leakage in vehicle		L	L	
<b>Date:</b> July 10, 2003 <b>Process:</b> 5. CNG <b>Study Section:</b> 5B. Natural Gas Compression <b>Design Intent:</b> Compress natural gas from 20 psig to 4,000 psig							
3.	Compressor suction line failure	Mechanical failure of line or fitting	Overpressure storage tank PRV. Release of natural gas and potential fire or explosion	Gas is odorized Combustible gas detectors	L	M	Piping in the entire system should be designed to ASME B31.3 code
4.	Cooling system failure	Loss of cooling fluid	Reduce piston life <b>No safety hazard</b>		-	-	
5.	Lubrication system failure	Loss of fluid	Release of natural gas and potential fire or explosion	Gas is odorized Combustible gas detectors Low oil pressure shutdown	L	M	
6.	Seal failure	Mechanical failure	Release of natural gas and potential fire or explosion	Gas is odorized Combustible gas detectors	L	M	
7.	Compressor suction or discharge valve failure	Mechanical failure	<b>No safety hazard</b>		-	-	

2-1-1



No.	Failure Mode	Cause	Effects	Controls	F	C	Recommendation
8.	Pressure relief device fails open	Mechanical failure	Relief valves are vented to a stack <b>No safety hazard</b>		-	-	
9.	Valve on discharge of compressor fails closed	Mechanical failure or human error and failure of pressure relief valve to open	Overpressure compressor and rupture line. Release of natural gas and potential fire or explosion	Gas is odorized Combustible gas detectors	L	M	
10.	High pressure (4,000 psig) natural gas supply line failure	Mechanical failure	Release of natural gas and potential fire or explosion	Gas is odorized Combustible gas detectors	L	M	
<b>Date:</b> July 10, 2003 <b>Process:</b> 5. CNG <b>Study Section:</b> 5C. Natural Gas Storage <b>Design Intent:</b> Store compressed natural gas at 4,500 psig							
11.	 Overpressure and failure storage tank (MAWP 4,000 psig)	Fill storage tank on cold day to 4,500 psig Heat stored gas during day	Release of natural gas and potential fire or explosion	Maximum pressure due to thermal expansion is approximately 5,200 psig based on 50°C increase in temp	M	M	Review climate conditions in safety plan
12.	 Relief device failure (on cylinders) fails open	Mechanical failure	Release of natural gas and potential fire or explosion	Relief devices vent to stack Gas is odorized Combustible gas detectors	L	L	Storage system should contain redundant relief devices
13.	Storage tank failure	Mechanical failure, corrosion,	Release of natural gas and potential fire or explosion	Storage tank MAWP 4,000 psig	L	H	Storage system should contain redundant relief devices
14.	Piping leak	Mechanical failure	Release of natural gas and potential fire or explosion	NFPA 52 setback distances Gas is odorized Combustible gas detectors	L	H	
15.	Storage tank failure	External fire due to large spill of gasoline from delivery truck	Potential failure of tank due to overheating of metal	NFPA 52 setback distances Gas is odorized Combustible gas detectors	L	H	Design and codes should consider stations dispensing both CNG and gasoline

No.	Failure Mode	Cause	Effects	Controls	F	C	Recommendation
<b>Date:</b> July 10, 2003 <b>Process:</b> 5. CNG <b>Study Section:</b> 5D. CNG Dispensing <b>Design Intent:</b> Dispense 680 SCF per vehicle at 3,000 or 3,600 psig							
16.	Piping failure	Vehicle impact to dispenser	Potential fire or explosion	Bollards around dispenser	L	H	
17. ✂	Dispenser cascade control failure	Pressure relief device on dispenser and storage tanks fails	Overpressure vehicle fuel tank Relief valve on vehicle tank vents	CNG filling uses different heat of compression compensation than hydrogen	L	H	
18. ✂	Use wrong pressure nozzle (3,600 psig vs 3,000 psig)	Human error	Potential overpressure of vehicle fuel tank	Nozzles designed to prevent 3,600 psig nozzle to be attached to a 3,000 psig tank	L	M	In CNG service older vehicles have a variety of different type fittings
19.	Drive away while connected to dispenser	Human error	Rupture hose and potential fire or explosion	Break away connection with poppet isolation valves	L	M	
20.	Hose failure	Mechanical failure	Potential fire or explosion	Hoses rated for CNG service	L	M	Should be tested or inspected on a regular basis
21.	Leak in connection	O-ring damaged or nozzle damaged	Potential fire	Dispenser conducts leak check prior to each fill	M	L	
22.	Vehicle pressure relief device leaks	Mechanical failure	Potential fire or explosion	Relief valve on vehicle tank vents	L	M	
23.	Fail to vent nozzle before disconnecting	Human error	No safety hazard	Venting before disconnecting is automatic, and is built into the nozzle	-	-	
24.	Vehicle tank back-flows through dispenser vent.	Foreign matter in vehicle check valve (Gas back flows when 3-way valve turned to vent).	Potential fire or explosion	Ensure careful installation of piping to prevent introduction of foreign material.	L	M	

No.	Failure Mode	Cause	Effects	Controls	F	C	Recommendation
25.	Nozzle leaks after disconnect	Mechanical failure	Potential fire	Dispenser valve closes	L	M	
26.	Vehicle tank isolation valve leaks	Mechanical failure	Potential fire or explosion		L	M	

**Table 3-13. Risk-Binning Matrix – CNG, Compressed Gas Fueling**

Combined Risk: Consequence x Frequency		Frequency (F)			Low or Negligible Risk
		Low (L)	Medium (M)	High (H)	
		Unlikely	Likely	Anticipated	
Consequence (C)	High (H)	6	0	0	Moderate Risk
	Medium (M)	12	1	0	High Risk
	Low (L) or Negligible (-)	2	1	0	

The highest risk levels assigned by the FMEA team were MM to failure modes, giving them a moderate risk status per the risk binning matrix. However, 10 additional failure modes that received the LH rating are also categorized into the moderate risk bins. In many cases, the FMEA team identified steps that would mitigate the moderate risks to lower levels.

Delivery of NG is a very common procedure and the FMEA team did not identify any unique risks associated with this process. High pressure compression, storage, and dispensing are conceptually similar in design and function to the other fueling stations considered here.

MM ratings were also assigned to scenarios in the fuel storage and vehicle dispensing sections of the fueling station. These scenarios apply to all of the fuel supply options. Both of these scenarios relate to an over pressure of the fuel tank and subsequent release of methane from the pressure relief valve or vehicle pressure relief device. The range in ambient temperature swings is taken into account in fueling station design; however, unusual temperature variations are possible. A failure in the instrumentation associated with the temperature compensation system could result in the overpressure of a vehicle tank during fueling.

The consequence risk rating for most failure modes was greatly influenced by the existing controls or lack of any controls. For example, in the cases where a NG leak detector was present as a control, the resulting consequence risk level was mitigated to either an M or an L from an almost certain H in the absence of the control. The FMEA team observed that engineering design — equipment, system or civil/architectural design — played an important role in the associated risk level. A simple example is the case of bollards protecting dispensing and piping equipment, which significantly lower the frequency of catastrophic accidents from occurring.

Many of these top-level occurrences are a product of sub-events that individually may have had an H-rating but were undermined by associated lower risk sub-events. A single failure mode may be the result of a sequence of sub-events each of which has an associated frequency of occurrence. In such cases, the relative risk rating that was assigned by the FMEA team to the failure mode occurrence frequency was the sub-event frequency with the lowest risk rating. Typically this sub-event would prevent other sub-events with higher risk-ratings from materializing. For example, consider the scenario where a fire or explosion may occur due to a vehicle drive-away during dispensing (No. 19, Table 3-10)<sup>5</sup>. This scenario is unavoidable in all fueling station types because of the potential for human error.

The drive-away on its own was considered to be a relatively high frequency (H) event. However, for ignition to occur under this failure mode, in addition to the drive-away the break away connection has to fail and the hose must rupture, followed by failure of the poppet isolation valves and finally an ignition source must be present. At least two of the four sub-events to drive away were assigned a low (L) frequency of occurrence and hence the overall risk rating for the frequency of this failure mode occurring was assigned a low (L). The frequency of occurrence for many of the failure modes resulted with L and M designations by the FMEA team.

<sup>5</sup> This example is repeated in each FMEA for readers who are interested in only one supply option.



## 4. FUELING STATION DOCUMENTATION — FMEA INPUTS

### 4.1 Liquid Hydrogen Documentation

#### Liquid Hydrogen Delivery

A cryogenic tank truck delivers liquid hydrogen to the fueling station, which transfers the liquid to the station tank. Because of its much higher density (as discussed in Section 5), considerably more hydrogen is transported as a cryogenic liquid in tank trucks than as a compressed gas in tube trailers. The delivered liquid is maintained at temperatures below  $-250^{\circ}\text{C}$  ( $-420^{\circ}\text{F}$ ) in one or more vacuum-jacked vessels at the station.

In this station design, the liquid is warmed in a heat exchanger. The vapor from boil-off or warmed liquid is compressed into high-pressure gas storage vessels that supply the dispensers. This approach was selected because of the design basis for the fueling station. Alternatively, for stations with a throughput high enough that boil-off vapor is negligible, the liquid can be pumped to high pressure and then vaporized. This reduces costs by eliminating the multi-stage compressor and its substantial drive power requirements. Figure 4-1 illustrates the pressure-enthalpy pathway for converting liquid hydrogen to compressed gas. Both vaporizer/compressor and cryogenic pump pathways are indicated.

One disadvantage of liquid hydrogen delivery is the potential for boil-off as heat enters the cryogenic storage tank. Some boil-off loss inevitably occurs at various points in the infrastructure chain. This boil-off loss can be negligible for fuel stations with a high throughput, but it can be substantial for low-throughput stations (e.g., where liquid hydrogen deliveries are less frequent than once per week). Additional consideration of boil-off losses is included in subsequent discussions of fueling station design and components.

The broken-line curve in Figure 4-1 is the hydrogen saturation “dome.” Hydrogen is a liquid to the left of this dome, a vapor to the right, and a liquid-vapor mixture within the dome. Hydrogen’s critical point is at the peak of the dome, and hydrogen above this point is said to be supercritical.

The vaporize-and-compress option starts with the horizontal line extending to the right from the liquid side of the dome in Figure 4-1. This line denotes vaporization of the liquid hydrogen (from the left to the right side of the dome) followed by warming of the hydrogen gas to ambient temperature. “Vaporizer” is technically a misnomer, since substantially more heat transfer is needed to warm the gas than to vaporize the liquid. In Figure 4-1’s example, the ambient-temperature of  $70^{\circ}\text{F}$  hydrogen is assumed to be compressed to 5,000 psi in a four-stage compressor with intercooling after each stage.

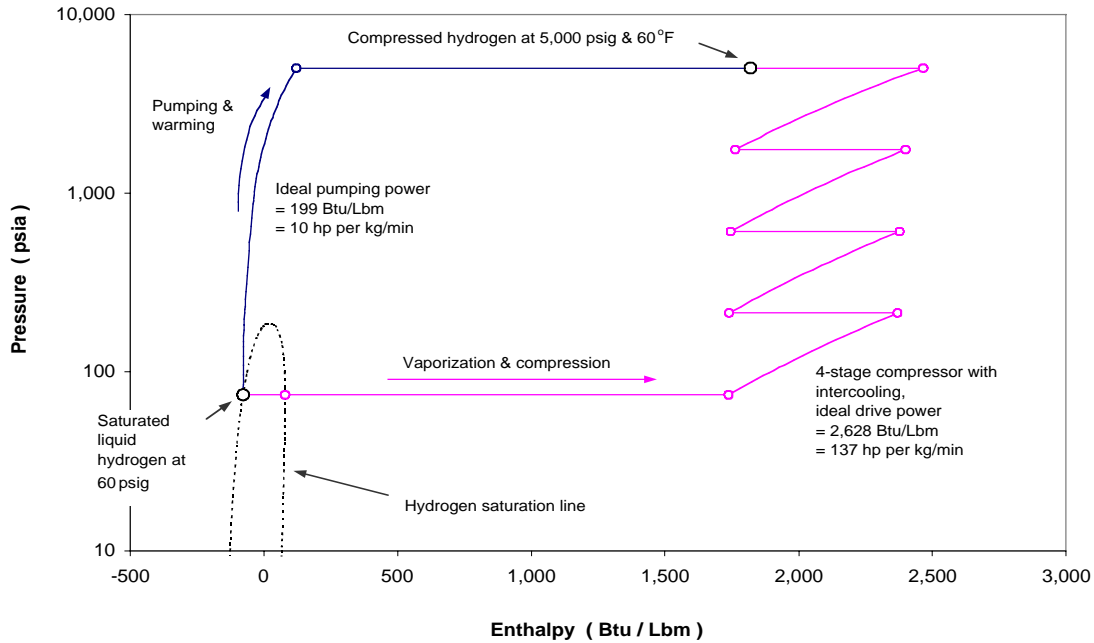

**Figure 4-1. Pressure versus Enthalpy for Equilibrium Hydrogen, Illustrating Two Alternative Paths for Dispensing Compressed Hydrogen from Stored Liquid Hydrogen**

The advantage of the vaporize-and-compress strategy is that it produces less boil-off vapor and it can process some or all of the vapor that must be vented if a pump is used.<sup>6</sup>

The liquid hydrogen storage tank is obviously a key component. A 12,000-gallon tank was analyzed for this vehicle fueling application. With a vehicle fueling rate of 10 cars per day, the tank could be managed to avoid boil off and venting of hydrogen. While venting hydrogen vapor from the tank does not pose a safety risk, it is desirable to use the product for vehicle fueling. Figure 4-2 illustrates how the tank pressure would vary if fuel were drawn either from the vapor or liquid space. A combination of 38 percent of the fuel drawn from the vapor space with the balance from the liquid would maintain a constant pressure in the liquid tank and eliminate the need for venting. The calculations that demonstrate the thermal management of the liquid hydrogen verified that the component sizing of the fueling station was appropriate for a 10 vehicle per day demand.

<sup>6</sup> An exception is the previously mentioned cryogenic pump-compressor combinations that can process liquid and vapor mixtures.



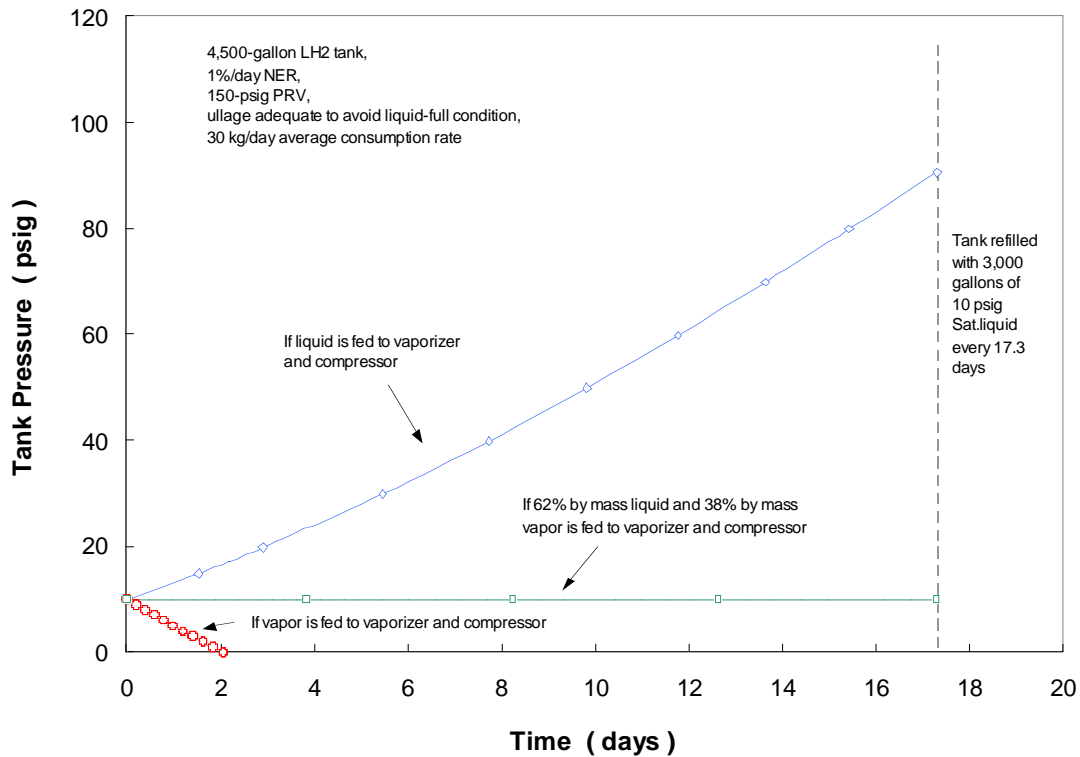

**Figure 4-2. Illustration of Liquid Hydrogen Storage Tank Saturation Pressure Variation: Pressure Changes for Noted Conditions for Withdrawal of Liquid, Vapor, or Liquid-vapor Mixture**

All cryogenic hydrogen tanks of this type are of vacuum-jacketed construction. The inner tank is typically stainless steel designed and tested in a manner consistent with the ASME pressure vessel code. The outer tank or “jacket” is typically carbon steel. The interstitial vacuum space is filled with a low-conductivity granular material such as Perlite or multi-layer insulation (MLI) to minimize both radiation and convection heat transfer. The inner tank has various pressure-relief devices consistent with applicable codes. This includes pressure-relief valves backed up by rupture disks, which open to vent product to preclude over-pressuring the inner tank. There are usually two sets of these valve/disk combinations so that one set can be isolated (e.g., for valve testing or disk replacement). The outer vessel is not a pressure vessel, and therefore it is fitted with a relief device so that it vents if the inner tank leaks into the vacuum space. Two important specifications (in addition to capacity) affecting liquid hydrogen tanks are the maximum allowable working pressure (MAWP) and normal evaporation rate (NER).<sup>7</sup>

<sup>7</sup> NER is usually expressed as a percent of the tank capacity that evaporates per day due to heat leaks. It is important to note if the NER is specified in terms of a gas other than hydrogen and the vent pressure associated with the NER specification.

The hydrogen liquid and vapor phases in the storage tank are generally at or near saturation (i.e., equilibrium), and both the saturation pressure and temperature increase with time, if there is no venting, as heat leaks into the tank. The saturation pressure and temperature of the hydrogen delivered by the tank truck is relatively low because it is “fresh” from the liquefier. There are two possible strategies for using cryogenic liquid hydrogen tanks in a fueling station application. One option is to equip the tank with a pressure-regulator valve so that it vents to maintain a constant pressure less than the MAWP. The other option is to allow the tank pressure to increase from the relatively low level following tank-truck delivery up to the PRD setting. If the station throughput is high enough and the delivery of fresh “cold” liquid hydrogen is frequent enough, then the storage tank pressure will never reach the PRD setting and no product will be lost due to venting.

Similar to the other fuel supply options, the fuel station components reflect sizing for fueling 10 vehicles per day. A gas compressor was sized to operate six hours a day to fuel 10 vehicles. Consequently, the fueling station could handle a larger vehicle fueling rate. The larger compressor capacity reduces the requirement for on-site storage compared with on-site production options.

Table 4-1 summarizes the liquid hydrogen equipment and product specifications. Table 4-2 is a summary of the codes and standards applicable to liquid hydrogen storage. Figures 4-3 through 4-5 show representative process flow diagrams (PFD), piping and instrument diagrams (P&ID), and site layout plan.

**Table 4-1. Liquid Hydrogen Equipment and Product Specification**

Item	Specification
Cryogenic Delivery Truck	<ul style="list-style-type: none"> <li>• 12,000 gal</li> </ul>
Cryogenic Liquid Hydrogen Storage Tank	<ul style="list-style-type: none"> <li>• 5,000 gallon capacity</li> </ul>
Vaporizer/Heat Exchanger	<ul style="list-style-type: none"> <li>• 5 kg/hr flow rate</li> </ul>
Hydrogen Compressor	<ul style="list-style-type: none"> <li>• Compress to 6,250 psi</li> <li>• 4 kg/h nominal Class I, Division 1, Group B Service</li> <li>• Explosion proof equipment in open area</li> </ul>
Compressed Hydrogen Storage Vessels	<ul style="list-style-type: none"> <li>• 39 kg H<sub>2</sub> capacity</li> <li>• 1.1 WC m<sup>3</sup> H<sub>2</sub> capacity at 6,250 psi</li> </ul>
Compressed Hydrogen Dispenser	<ul style="list-style-type: none"> <li>• Fueling at 5,000 and 3,600 psi</li> <li>• Sherex nozzles with three-way valve</li> <li>• Break-away coupling of nozzle</li> </ul>

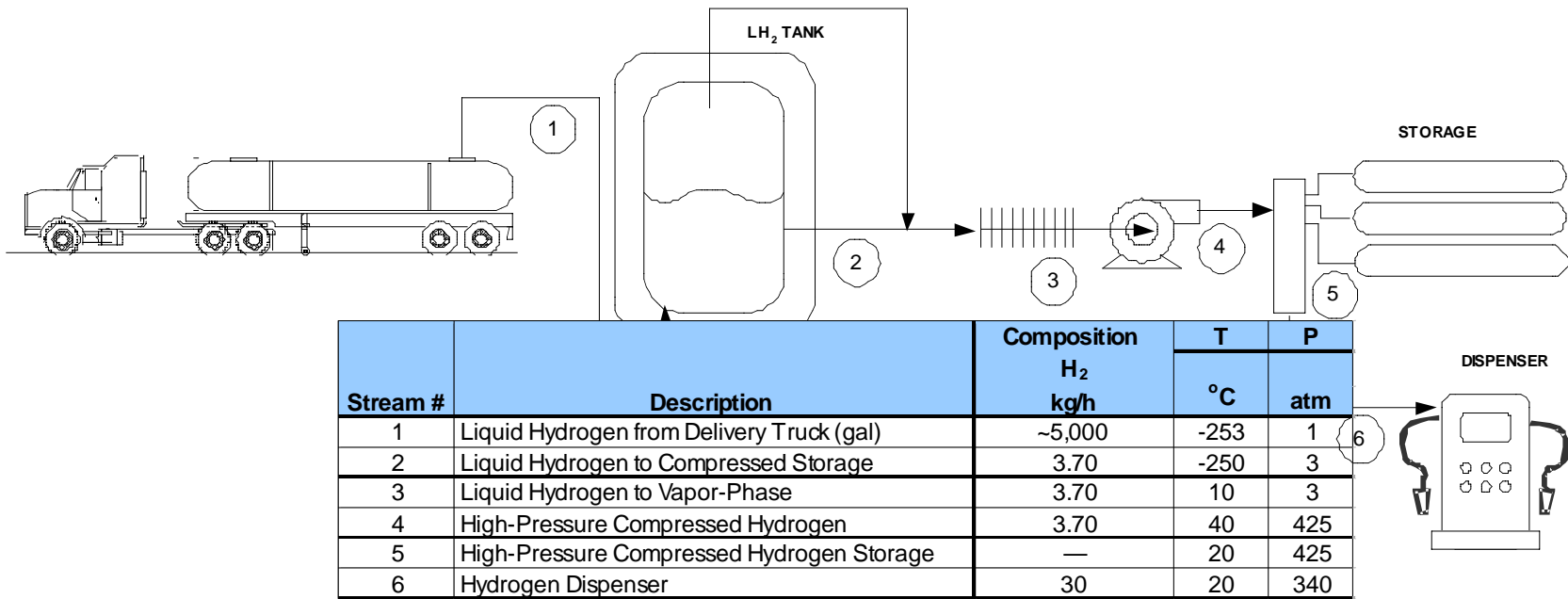
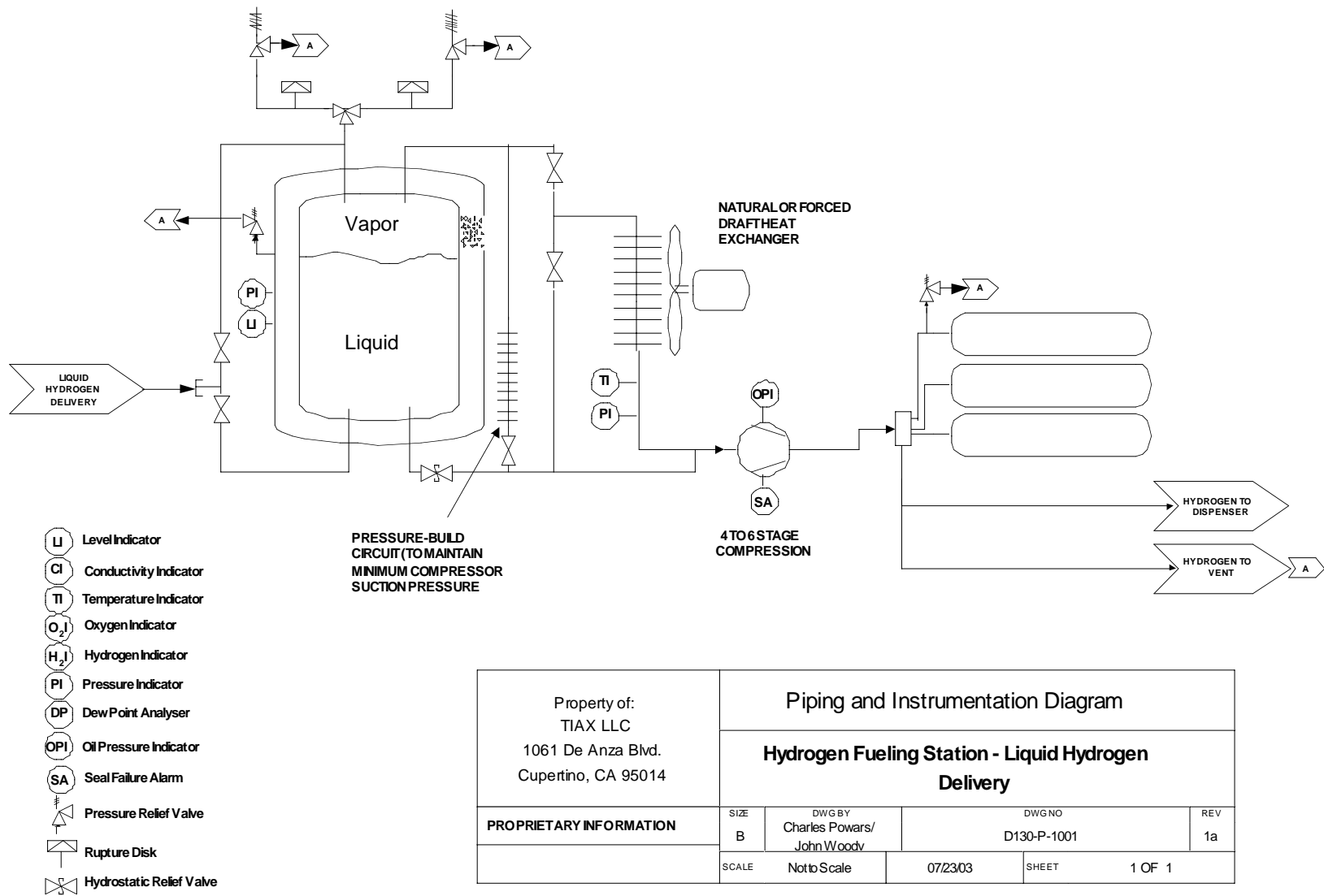

Figure 4-3. Process Flow Diagram for Liquid Hydrogen Refueling



**Figure 4-4. Piping and Instrumentation Diagram for Liquid Hydrogen Refueling**

**Table 4-2. Codes and Standards Regarding Compressed and Liquid Hydrogen Storage**

Element of Station	Distance from Gaseous Hydrogen Storage			Distance from Liquid Hydrogen	
	NFPA 50A	IFGC 704.2	IFC 2209.3.1.1	NFPA 50B	IFC 2206.3.1.2
Walls with minimum fire rating	5 ft (2 hour)	—	—	5 ft. (3-hour)	—
Wall openings (doors & windows)	25 ft	—	—	75 ft.	—
Intake vents	50 ft	—	—	75 ft	—
Lot Line	5 ft	10 ft	15 ft	25 ft	—
Places of public assembly	50 ft	—	—	75 ft	—
Parked vehicles	15 ft	—	—	25 ft	—
Gasoline Storage	50 ft	—	—	50 ft	—
Overhead Electric Wire	—	5 ft	0 ft	—	3 ft
Cement Block Wall	0 ft	0 ft	5 ft	—	15 ft
Public sidewalks	15 ft	10 ft	15 ft	25 ft	-
Overhead Trolley Bus Wire	—	50 ft	—	—	—
Office/Store	—	—	—	—	—
Building having noncombustible wall surfaces that are not part of a 1 hour fire resistant-rated assembly	—	—	25 ft	—	—
Ignition Source	25-50 ft 0 ft w/2-hour wall	10 ft	25 ft	—	50 ft
Gasoline and Hydrogen Dispensing	—	10 ft	15 ft	—	—
Office/Store	—	10 ft	15 ft	—	—
HVAC, doors, and windows	—	—	15 ft	—	—

### Liquid Hydrogen-Based Refueling Station Site Plan

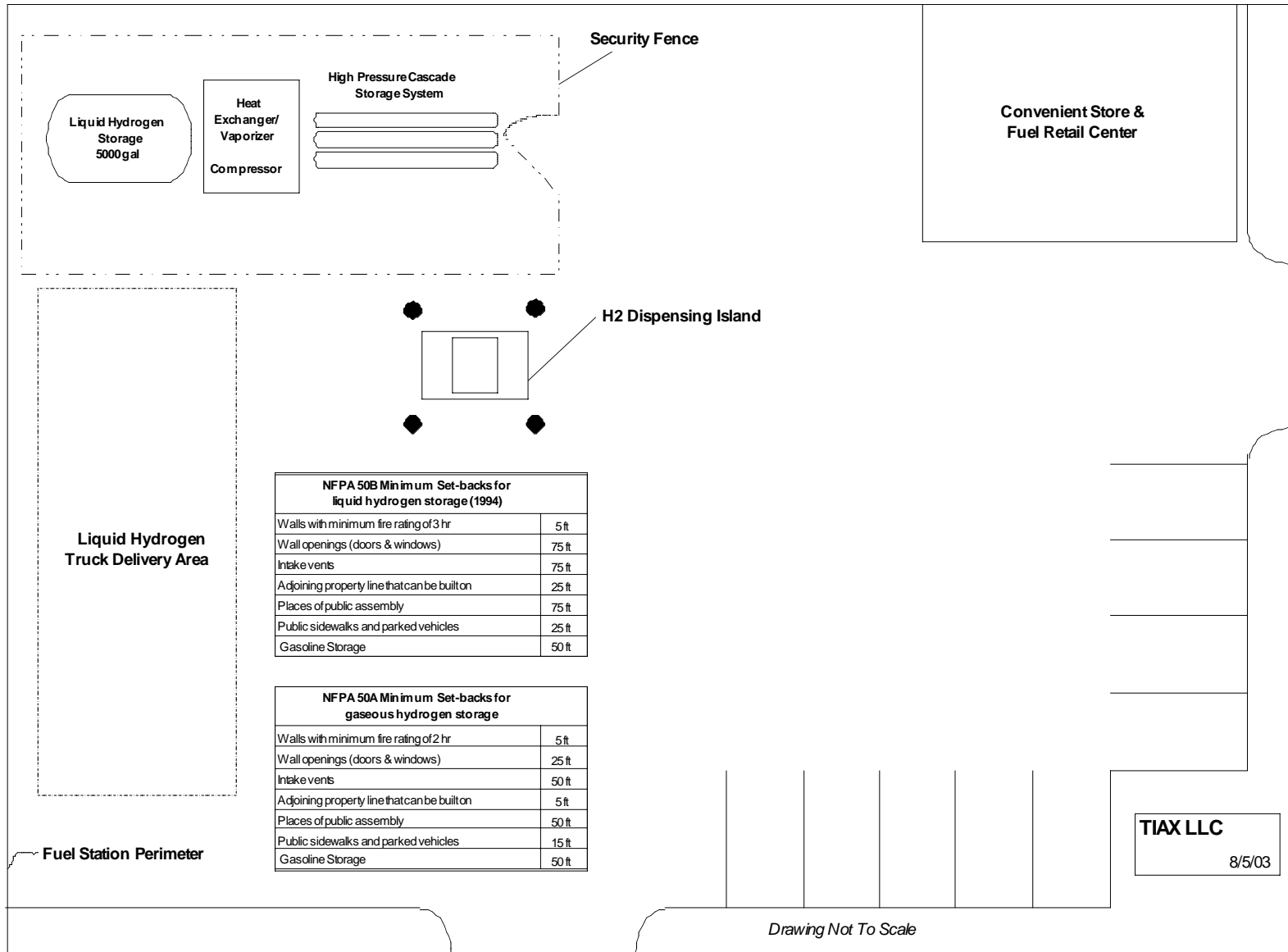
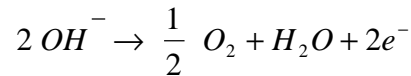

Figure 4-5. Liquid Hydrogen-Based Refueling Station Site Plan

## 4.2 Electrolyzer Documentation

### Process Description

Electrolysis is the process of splitting water into hydrogen and oxygen with electricity by transmitting an electrical current through an electrolyte. Oxygen and hydrogen gases are produced at the anode and the cathode respectively, separated from the electrolyte and gathered in separate vessels for further processing. The anode is the electrode through which the electrons leave the electrolytic cell and produces gaseous oxygen. The reaction at the anode is:



Similarly, the cathode is the electrode where electrons enter the electrolytic cell and promote the combination of hydrogen ions per the following reaction:

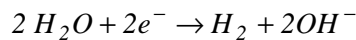

Alkaline and Solid Polymer Electrolyte Membranes (SPEM) are the two most common types of electrolysis used for hydrogen production. For this study, the electrolyzer-based hydrogen refueling station is an alkaline electrolyzer. Alkaline is the oldest electrolysis technology and the one most typically used for large-scale electrolytic hydrogen production. Many of today's units operate near ambient pressures and at temperatures between 80 and 145° C. The system in this study operates at 150 psi; the higher output pressure reduces compression costs.

### Equipment Description

The key components of an electrolyzer system include:

**Cells and electrodes:** Alkaline electrolyzers require the use of gas separators between the electrodes to prevent the migration of hydrogen to the oxygen side and vice versa. The electrodes must be able to withstand highly corrosive environments, be highly conductive, and have high surface activity. Hence, the electrodes are commonly porous and are usually constructed of nickel-based catalysts.

**Water Purification:** Demineralizer and carbon filter cartridges produce high quality water required by the process.

**Gas Generation System and Seals/KOH Handling:** Conductivity sensor, leak detector, feed water bowl level sensor, feed pumps, cell stack-temperature and water level control, ventilation blower, water seals, demisters, hydrogen ballast and hydrogen gas analyzer, a deoxydizer and peripheral cell components.

Hydrogen Purification and dryer system: A twin bed regenerative molecular sieve dryer, coalescing filters, and carbon adsorption filters provide clean contaminant free hydrogen for storage,

Table 4-3 summarizes typical equipment and utility specifications. Table 4-4 is a summary of the codes and standards applicable to electrolyzer-based system. Figures 4-6 through 4-8 show the representative PFD, P&ID, and site plans. Table 4-5 presents a typical station operating procedures, and Table 4-6 presents the various safety measures.

**Table 4-3. Electrolyzer Equipment and Product Specification**

Item	Specification
System Power Supply	<ul style="list-style-type: none"> <li>• 480 V, 3-Phase, 60 HZ</li> <li>• Power 325 kVA</li> </ul>
Electrolyzer Cells	<ul style="list-style-type: none"> <li>• 10 cell stack</li> <li>• Design Current 620 A DC</li> <li>• Cell Voltage 1.9V</li> <li>• Operating Temperature 63°C Max.</li> <li>• Operating Pressure 150 psig</li> <li>• Electrolyte 34% KOH</li> <li>• Feedwater Flowrate Total 4 GPH</li> </ul>
Feedwater Supply	<ul style="list-style-type: none"> <li>• Demineralized</li> <li>• Flow rate 4 GPH</li> </ul>
Hydrogen Catalytic Purifier	<ul style="list-style-type: none"> <li>• Rated 02 PPM by Vol: 2-5</li> <li>• Operating Pressure 250 psig max.</li> <li>• Operating Temperature 60°C max.</li> </ul>
Hydrogen Dryer	<ul style="list-style-type: none"> <li>• Operating Pressure 250 psig max.</li> <li>• Operating Temperature 35°C</li> <li>• Rated Dew point -55°C</li> </ul>
Product Hydrogen	<ul style="list-style-type: none"> <li>• 99.99% purity hydrogen</li> <li>• 1.25 kg/h, 8.6 scfm</li> </ul>
Piping Systems	In conformance with : <ul style="list-style-type: none"> <li>• ASME B31.8: Gas Transmission &amp; Distribution Piping Systems – for process piping</li> <li>• CGA G-5.4: Standard for Hydrogen Piping Systems at Consumer Location – hydrogen piping</li> </ul>
Equipment and Area Classification	<ul style="list-style-type: none"> <li>• Electrical equipment in conformance with NFPA 70</li> <li>• Unclassified ventilated enclosure</li> </ul>
<b>Other Equipment</b>	
Hydrogen Compressor	<ul style="list-style-type: none"> <li>• Compress to 6,250 psi</li> <li>• 1.25 kg/h, 8.6 scfm</li> </ul>
Compressed Hydrogen Storage Vessels	<ul style="list-style-type: none"> <li>• 78 kg H<sub>2</sub> capacity</li> <li>• 3.03 WC m<sup>3</sup> H<sub>2</sub> capacity at 6,250 psi</li> </ul>
Compressed Hydrogen Dispenser	<ul style="list-style-type: none"> <li>• Fueling at 5,000 and 3,600 psi</li> <li>• Sherex nozzles with three-way valve</li> <li>• Break-away coupling of nozzle</li> </ul>



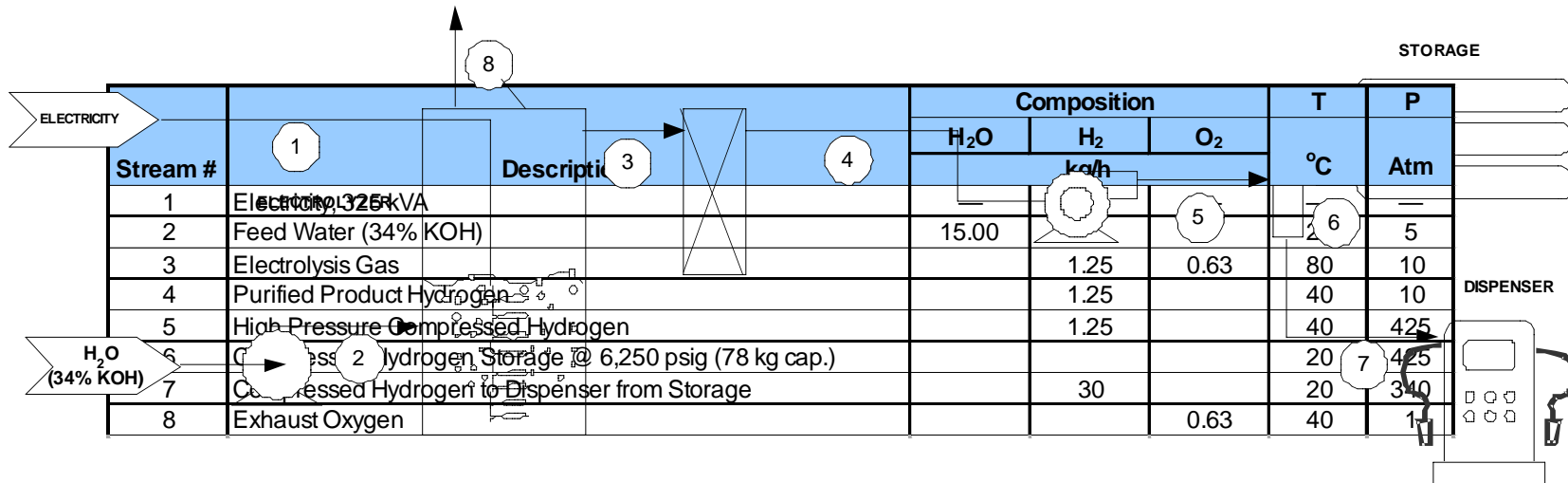
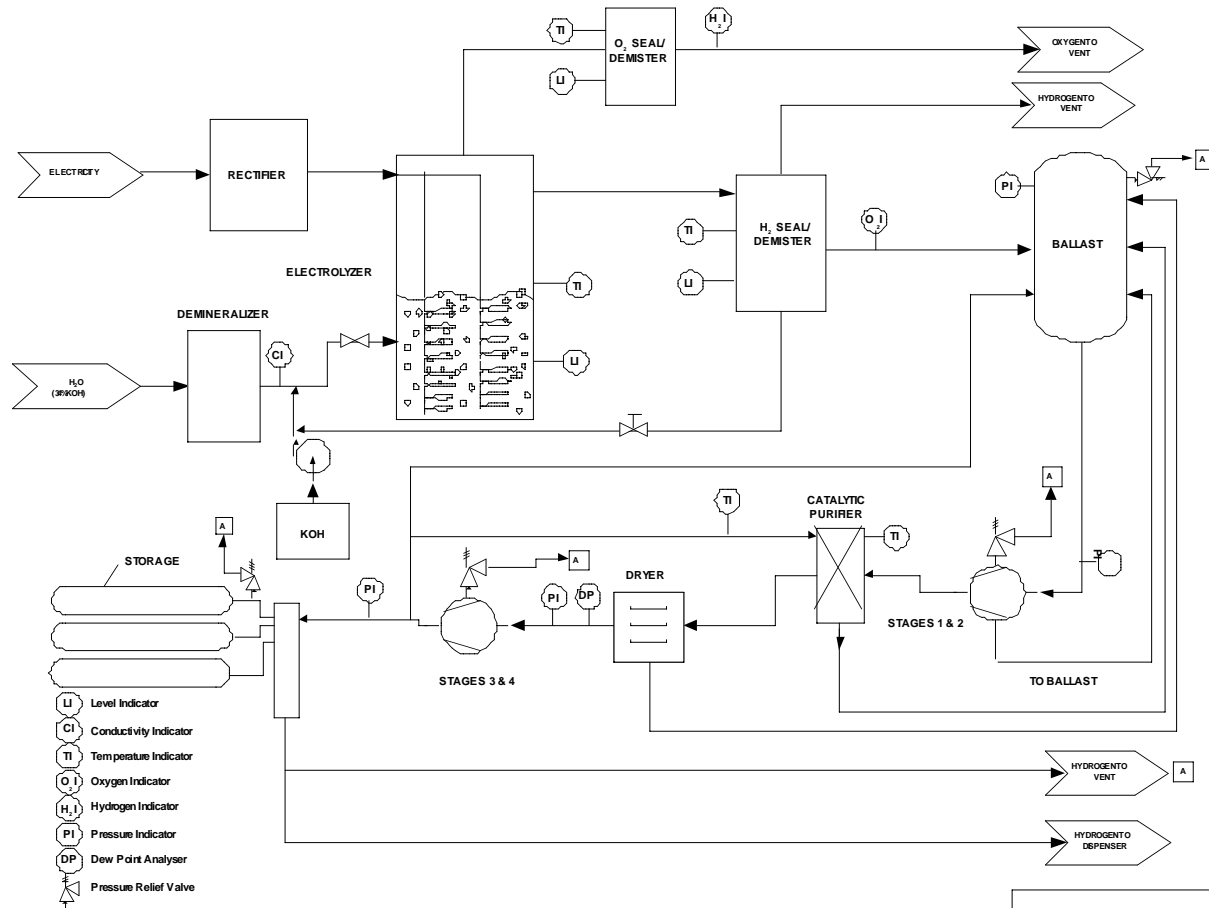

Figure 4-6. Electrolyzer-Based Refueling Station Process Flow Diagram



Property of: TIAX LLC 1061 De Anza Blvd. Cupertino, CA 95014	Piping and Instrumentation Diagram		
	Hydrogen Fueling Station - Onsite Electrolyzer		
<b>PROPRIETARY INFORMATION</b>	SEE B	DWG BY John Woody	DWG NO D130-P-2001
	SCALE Not to Scale	07/16/03	SHEET 1 OF 1
			REV 1a

**Figure 4-7. Piping and Instrumentation Diagram for Electrolyzer-Based Refueling**

**Table 4-4. Codes and Standards Regarding Compressed Hydrogen Storage**

Element of Station	Distance from Gaseous Hydrogen Storage		
	NFPA 50A	IFGC 704.2	IFC 2209.3.1.1
Walls with Minimum Fire Rating	5 ft (2-hour)	—	—
Wall Openings (doors & windows)	25 ft	—	—
Intake Vents	50 ft	—	—
Lot Line	5 ft	10 ft	15 ft
Places of Public Assembly	50 ft	—	—
Parked Vehicles	15 ft	—	—
Gasoline Storage	50 ft	—	—
Overhead Electric Wire	—	5 ft	0 ft
Cement Block Wall	0 ft	0 ft	5 ft
Public Sidewalks	15 ft	10 ft	15 ft
Overhead Trolley Bus Wire	—	50 ft	—
Office/Store	—	—	—
Building having noncombustible wall surfaces that are not part of a 1 hour fire resistant-rated assembly	—	—	25 ft
Ignition Source	25-50 ft 0 ft w/2-hour wall	10 ft	25 ft
Gasoline and Hydrogen Dispensing	—	10 ft	15 ft
Office/Store	—	10 ft	15 ft
HVAC, Doors, and Windows	—	—	15 ft

### Electrolyzer-Based Refueling Station Site Plan

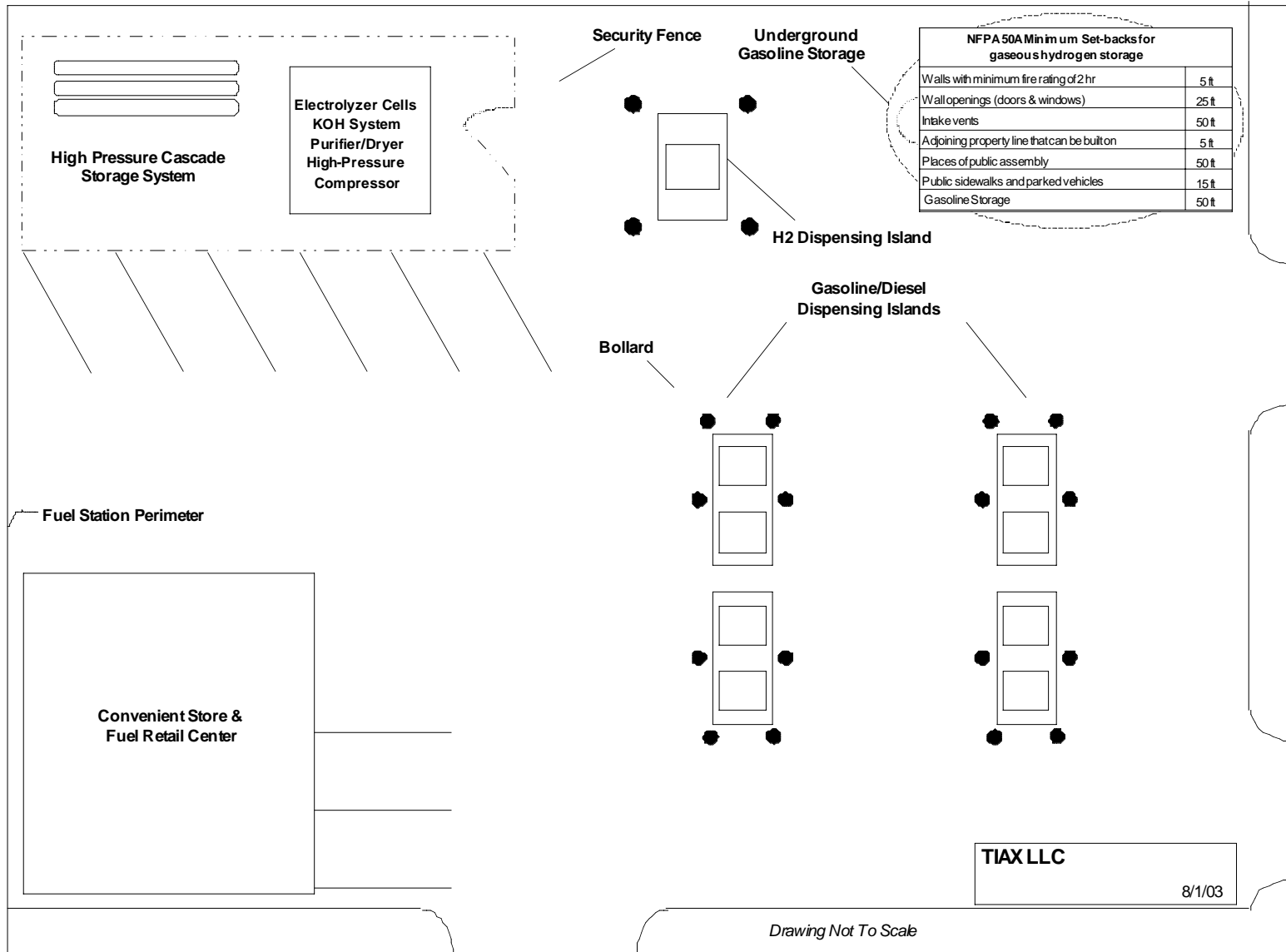

4-14

Figure 4-8. Electrolyzer-Based Refueling Station Site Plan

**Table 4-5. Electrolyzer-Based Refueling Station Operating Procedures**

Step	Key Equipment Involved	Example Operating Sequences
1. System Startup & Operation	<ul style="list-style-type: none"> <li>• Electrolyzer</li> <li>• KOH System</li> <li>• Auxiliary Cooling System</li> <li>• Purification/Drying</li> <li>• Compression</li> <li>• Storage System</li> </ul>	<p>Initiate following start-up sequence using a computerized SCADA system – Turn “ON” switch to result in the following actions</p> <ol style="list-style-type: none"> <li>1. Start cooling water circulation and air cooling blower fans</li> <li>2. Fill cells with electrolyte solution (34% KOH) to operating levels.</li> <li>3. Power Rectifier. Start current ramp-up</li> <li>4. Enable normal feed of all electrolyte cells</li> <li>5. Start 3-stage high-pressure compressor system to storage system when hydrogen flow-rate and line pressure set-points are reached</li> <li>6. Shut down power to rectifier when storage system set-point pressure of 6,250 psig is reached.</li> </ol>
2. System Shutdown	<ul style="list-style-type: none"> <li>• Electrolyzer</li> <li>• KOH System</li> <li>• Auxiliary Cooling System</li> <li>• Purification/Drying</li> <li>• Compression</li> <li>• Storage System</li> </ul>	<p>Initiate following start-up sequence using a computerized SCADA system – Turn “OFF” switch to result in the following actions.</p> <ol style="list-style-type: none"> <li>1. Shut down power to rectifier</li> <li>2. Shut down compressor system</li> <li>3. Turn-on purge/blanket Nitrogen valve</li> <li>4. Allow system to reach “off” set-point temperature of ambient</li> <li>5. Shut down cooling water and air blowers</li> </ol>
3. Dispensing/ Vehicle Refueling	<ul style="list-style-type: none"> <li>• Dispenser</li> <li>• Vehicle</li> </ul>	<ul style="list-style-type: none"> <li>• Dispensing follows the CA FCP protocol for vehicle fueling including communication with the vehicle and dispenser</li> <li>• Dispenser is activated with a card-lock/PIN mechanism</li> <li>• Following connection of the hose with the correct receptacle (5,000-psi vs. 3,600-psi) fueling commences</li> <li>• When fueling is complete, dispenser is turned off. The receptacle release lever also serves to vent fugitive gas back to the dispenser.</li> </ul>

**Table 4-6. Electrolyzer-Based Refueling Station Safety Measures**

Safety	Example Measures
Equipment	<ul style="list-style-type: none"> <li>• The electrolyzer unit operates under a pressure of 125 psig and is designed for 275 psig. The rectifier has output amperage of 620 ADC and is equipped with automatic shut-off switches for temperature and power overload conditions. The electrolyzer unit room is designed with a minimum 5-ft safety and maintenance envelope and in compliance with NFPA 70 standards.</li> <li>• The compressor system is equipped with safety relief valves. Safety switches connected to the overall system PLC, and OSHA standard belt guards.</li> <li>• The storage tanks store compressed hydrogen gas at 6,250 psi. These tubes are also designed to ASME standards with a design pressure of 7,255 psi, and tested to 1.5 times that level. The tanks are equipped with relief valves to release any overpressure.</li> <li>• The two dispensers operate at pressures of 5,000 psi and 3,600 psi respectively. They utilize connectors that include over-pressure protection, remote shutoff capability, a breakaway connector (in case the car is driven away while the fill hose is attached) and non-interchangeable nozzles (to prevent inadvertent use of a 5,000 psi dispenser with a car designed with a 3,600 psi tank).</li> </ul>
Process	<ul style="list-style-type: none"> <li>• Maintenance activities follow OSHA 1910.147 lock-out tag-out procedures.</li> <li>• The entire refueling system is designed for unattended operation for extended periods and can be monitored locally via a PC. The system is designed for fail safe shutdown and is provided with an emergency stop button and a remote shutdown contact. The unit can also be shutdown via the PLC. The system includes redundant combustibles detectors, a CO monitor and a fire detection system.</li> <li>• Dispensing follows the CAFCP protocol for vehicle fueling including communication with the vehicle and dispenser.</li> </ul>
Site	<ul style="list-style-type: none"> <li>• If not placed in a ventilated enclosure, equipment located in the hydrogen generator room is rated for Class I, Div. 2, Group B service.</li> <li>• The control system is located outside of the hydrogen generator room in a non-hazardous area classification.</li> </ul>

## 4.3 Steam Methane Reformer (SMR) Documentation

### 4.3.1 Hydrogen Generation

#### Process Description

Devices that produce hydrogen by reacting hydrocarbons with water are called reformers. The initial reaction products are principally hydrogen plus carbon monoxide, which is sometimes combined with more water in a shift reactor to produce hydrogen plus carbon dioxide. Natural gas is the most commonly used feedstock, although reformers can be designed to process almost any hydrocarbon. Steam methane reformers use methane, the principal constituent of natural gas, and steam to generate hydrogen. The overall reaction can be written as:

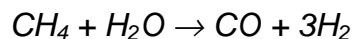

A typical SMR hydrogen generator consists of two main elements - the fuel processor and the pressure swing adsorption (PSA) purification unit. The fuel processor generates a reformat containing about 75 percent hydrogen. The fuel processor consists of a natural gas compressor, a desulfurizer to remove impurities from the natural gas feedstock, a preheat section, a steam-reformer, a high temperature shift reactor, a waste heat recovery steam generator, a process gas cooler, and a condensate separator. The fuel processor operates at about 120 psig pressure to produce reformat that can be sent directly to the PSA without further compression. The desulfurizer will remove impurities such as odorants and hydrogen sulfide. The steam reformer will convert the natural gas feedstock by reaction with steam to a synthesis gas containing relatively high concentrations of CO (8-10 dry vol. percent).

The shift reactor will reduce the CO concentration to less than 4.0 dry vol. percent. The process gas cooler and condensate separator will condense and recover moisture from the steam reforming process. The waste heat recovery steam generator will recover waste heat from the reformer flue gas and the process gas to generate steam for reforming. Hydrogen is purified in the PSA to a product containing > 99.99 percent hydrogen and less than five ppm CO. Lower CO concentrations can be achieved but at slightly reduced recovery efficiency. PSA tail gas consisting primarily of CO and other residual hydrocarbons is used as the reformer burner fuel.

#### Equipment Specifications

The on-site small-scale SMR plant uses the on-site natural gas for feed and as start-up fuel, de-ionized water for steam generation, and 208-240 VAC/60 Hz/ 3-phase electricity. Nitrogen is used to purge the system. The SMR is designed to produce

1.25 kg/h hydrogen. The system has a connection to a flue gas vent, a process safety valve relief vent, liquid drain line and a product hydrogen effluent line.

The unit is capable of unattended operation for extended periods and can be monitored locally via a personal computer. The SMR plant is designed for fail safe shutdown and is provided with an emergency stop button and a remote shutdown contact. The unit can also be shutdown via the PLC. The unit includes a combustibles detector, a CO monitor, and a fire detection system. All equipment located in the SMR cabinet/room is rated for Class I, Div. 2, Group B service. The control system is located outside of the hydrogen generator room in a non-hazardous area classification.

Table 4-7 summarizes typical equipment and utility specifications. Table 4-8 is a summary of the codes and standards applicable to SMR-based system. Figures 4-9 through 4-11 show the representative PFD, P&ID, and site plans. Table 4-9 presents a typical station operating procedures, and Table 4-10 presents the various safety measures.



**Table 4-7. SMR/PSA Equipment and Product Specification Summary**

Item	Specification
Generator Rated Capacity	1.25 kg/h
Delivery Pressure	150 psig
Delivery Temperature	40°C
Natural Gas Feed rate @ 6" w.c.	5.04 kg/h
Deionized Water Feed rate	2.5 GPM demineralized
Power Requirements	208-240 VAC/60Hz 3-Phase
Generator Turndown Ratio	3:1
Piping Systems	In conformance with : <ul style="list-style-type: none"> <li>• ASME B31.8: Gas Transmission &amp; Distribution Piping Systems – for process piping</li> <li>• CGA G-5.4: Standard for Hydrogen Piping Systems at Consumer Location – hydrogen piping</li> </ul>
Equipment and Area Classification	<ul style="list-style-type: none"> <li>• Electrical equipment in conformance with NFPA 70</li> <li>• Class I, Division 2, Group B Service</li> <li>• Ventilated enclosure</li> </ul>
Product Hydrogen Specification	<ul style="list-style-type: none"> <li>• 99.99% purity Hydrogen</li> <li>• &lt; 5 ppm CO</li> </ul>
<b>Other Equipment</b>	
Hydrogen Compressor	<ul style="list-style-type: none"> <li>• Compress to 6,250 psi</li> <li>• 1.25 kg/h flow rate</li> </ul>
Compressed Hydrogen Storage Vessels	<ul style="list-style-type: none"> <li>• 78 kg H<sub>2</sub> capacity</li> <li>• 2.88 WC m<sup>3</sup> H<sub>2</sub> capacity</li> </ul>
Compressed Hydrogen Dispenser	<ul style="list-style-type: none"> <li>• Fueling at 5,000 and 3,600 psi</li> <li>• Sherex nozzles with three-way valve</li> <li>• Break-away coupling of nozzle</li> </ul>

Stream #	Description	Composition (kg/h)										T °C	P A tm
		Nat. Gas	Air	O <sub>2</sub>	N <sub>2</sub>	H <sub>2</sub> O	H <sub>2</sub>	CO <sub>2</sub>	CO	THC	NO <sub>x</sub>		
1	Feed Natural Gas	5.04	—	—	—	—	—	—	—	—	—	40	2
2	Feed Water	—	10	—	—	13.38	—	—	—	—	—	20	10
3	Reformate Hydrogen	—	—	—	—	5.92	1.67	5.46	4.87	0.36	—	40	10
4	Purified Product Hydrogen from PSA to Compressor	—	—	—	—	—	1.25	—	—	—	—	40	10
5	High Pressure Compressed Hydrogen to Storage	—	—	—	—	—	1.25	—	—	—	—	40	425
6	Compressed Hydrogen Storage	—	—	—	—	—	—	—	—	—	—	20	425
7	Compressed Hydrogen to Dispenser from Storage	—	—	—	—	—	18.00	—	—	—	—	20	340
8	PSA Residual to Reformer as Fuel	—	—	—	0.14	0.12	0.42	8.46	4.87	0.36	—	40	1
9	Reformer Combustion Air	—	32.45	7.56	24.89	—	—	—	—	—	—	25	1
10	Reformer Combustor Exhaust Gas	—	—	—	25.03	1.99	—	14.11	—	—	2.7E-04	—	1

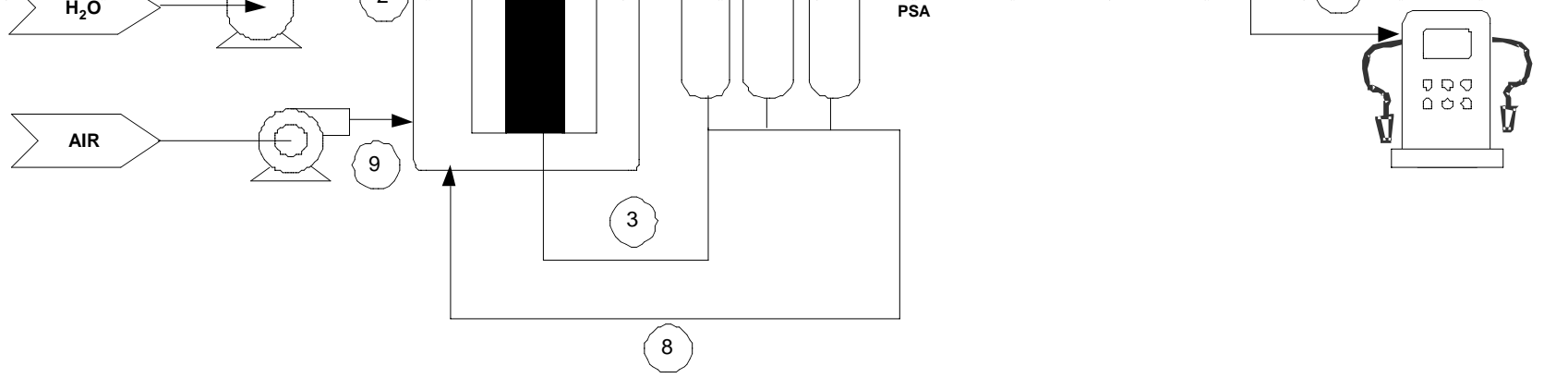

Figure 4-9. SMR-Based Station Process Flow Diagram

UC-V

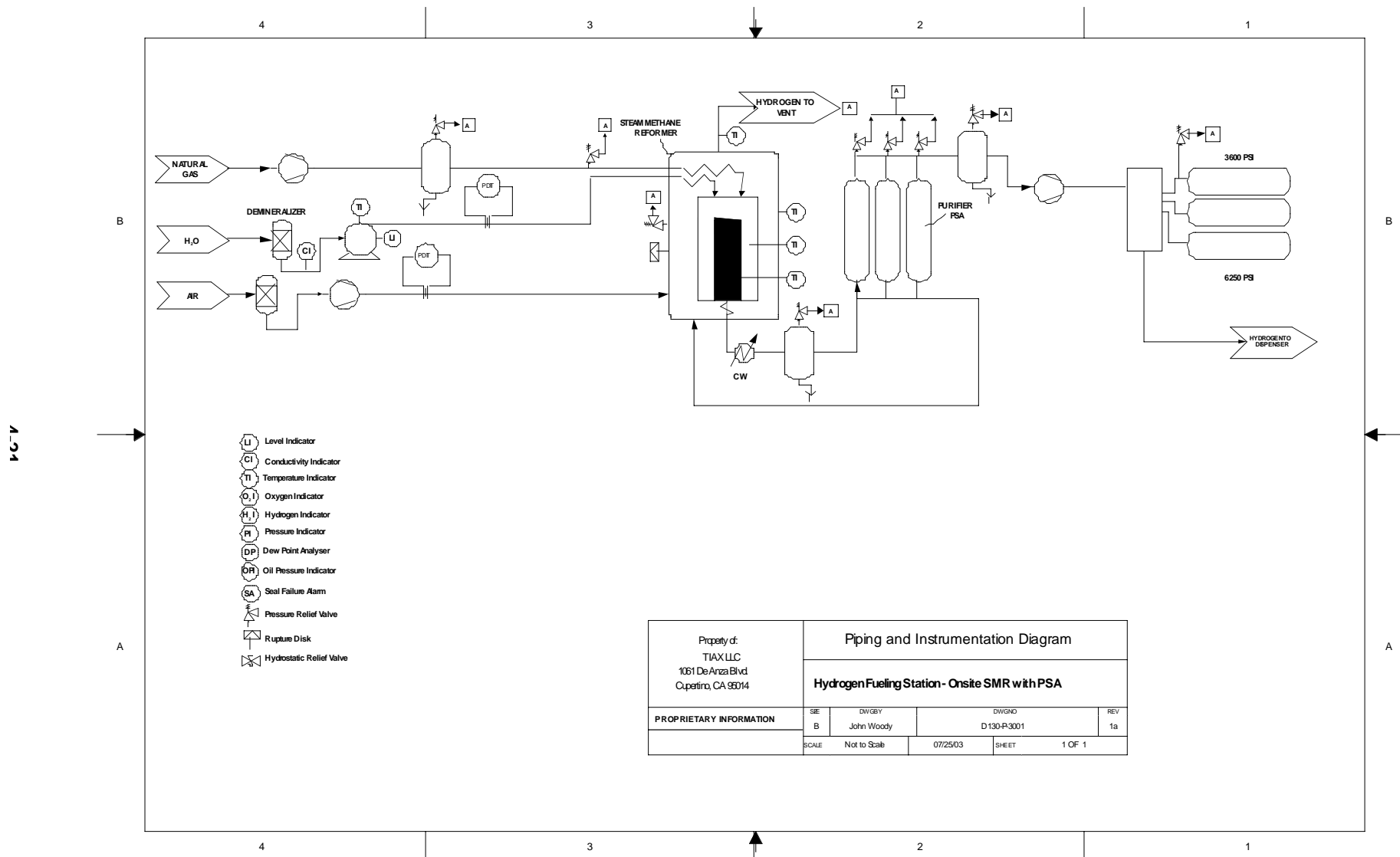
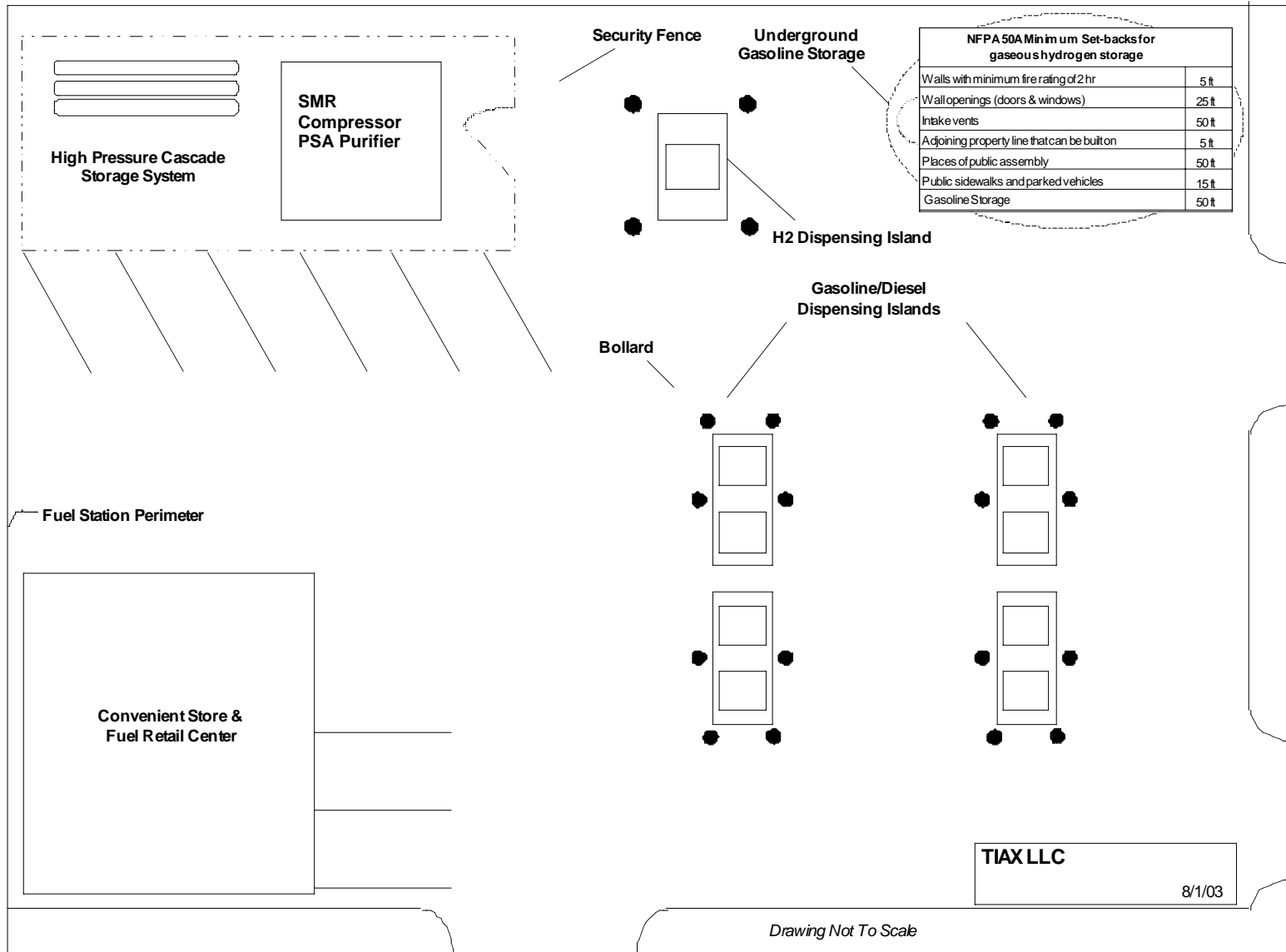

Figure 4-10. Piping and Instrumentation Diagram for Steam Methane Reforming-Based Refueling

**Table 4-8. Codes and Standards Regarding Compressed Hydrogen Storage**

Element of Station	Distance from Gaseous Hydrogen Storage		
	NFPA 50A	IFGC 704.2	IFC 2209.3.1.1
Walls with Minimum Fire Rating	5 ft (2-hour)	—	—
Wall Openings (doors & windows)	25 ft	—	—
Intake Vents	50 ft	—	—
Lot Line	5 ft	10 ft	15 ft
Places of Public Assembly	50 ft	—	—
Parked Vehicles	15 ft	—	—
Gasoline Storage	50 ft	—	—
Overhead Electric Wire	—	5 ft	0 ft
Cement Block Wall	0 ft	0 ft	5 ft
Public Sidewalks	15 ft	10 ft	15 ft
Overhead Trolley Bus Wire	—	50 ft	—
Office/Store	—	—	—
Building having noncombustible wall surfaces that are not part of a 1 hour fire resistant-rated assembly	—	—	25 ft
Ignition Source	25-50 ft 0 ft w/ 2-hour wall	10 ft	25 ft
Gasoline and Hydrogen Dispensing	—	10 ft	15 ft
Office/Store	—	10 ft	15 ft
HVAC, Doors, and Windows	—	—	15 ft

**Electrolyzer-Based Refueling Station Site Plan**



**Figure 4-11. SMR-Based Refueling Station Site Plan**

**Table 4-9. SMR-Based Refueling Station Operating Procedures**

Step	Key Equipment Involved	Example Operating Sequences
1 System Startup & Operation	<ul style="list-style-type: none"> <li>• Reformer</li> <li>• Air Blower</li> <li>• Water Pump</li> <li>• NG Compressor</li> <li>• PSA System</li> <li>• Compression System</li> <li>• Storage System</li> </ul>	<p>Initiate following start-up sequence using a computerized SCADA system – Turn “ON” switch to result in the following actions</p> <ol style="list-style-type: none"> <li>1. Start Air Blower</li> <li>2. Open NG and water valves from city mains</li> <li>3. Open secondary NG valve to reformer burner</li> <li>4. Reformer burner ignition</li> <li>5. Reformer combustion chamber reaches set-point temperature of 1,400°F</li> <li>6. Open primary water feed valve to reformer</li> <li>7. Open NG feed valve to reformer</li> <li>8. Start PSA system</li> <li>9. Open PSA residue valve to primary reformer burner</li> <li>10. Close secondary NG supply valve to reformer burner</li> <li>11. Start 3-stage high-pressure compressor system to storage system when PSA output H<sub>2</sub> concentration reaches 99.8%</li> <li>12. Storage system set-point pressure @ 6,250 psig</li> <li>13. Reformer turn-down and hydrogen reburn on when storage system has attained set-point pressure</li> </ol>
2. System Shutdown	<ul style="list-style-type: none"> <li>• Reformer</li> <li>• Air Blower</li> <li>• Water Pump</li> <li>• NG Compressor</li> <li>• PSA System</li> <li>• Compression System</li> <li>• Storage System</li> </ul>	<p>Initiate following start-up sequence using a computerized SCADA system – Turn “OFF” switch to result in the following actions.</p> <ul style="list-style-type: none"> <li>• Shut down feed NG and water valves</li> <li>• Turn-on purge/blanket Nitrogen valve</li> <li>• Shut down PSA and Compression systems</li> <li>• Reformer combustion chamber reaches “off” set-point temperature of ambient</li> <li>• Shut down air blower</li> </ul>
3. Dispensing/Vehicle Refueling	<ul style="list-style-type: none"> <li>• Dispenser</li> <li>• Vehicle</li> </ul>	<ul style="list-style-type: none"> <li>• Dispensing follows the CA Fuel Cell Partnership protocol for vehicle fueling including communication with the vehicle and dispenser</li> <li>• Dispenser is activated with a card-lock/PIN mechanism</li> <li>• Following connection of the hose with the correct receptacle (5,000-psi vs. 3,600-psi) fueling commences</li> <li>• When fueling is complete, dispenser is turned off. The receptacle release lever also serves to vent fugitive gas back to the dispenser.</li> </ul>

**Table 4-10. SMR-Based Refueling Station Safety Measures**

Safety	Example Measures
Equipment	<ul style="list-style-type: none"> <li>• The reformer reactor vessel and combustion chamber are designed to ASME standards with a design pressure of 250 psig. The reactor operates at a pressure of 125 psig. The reactor is equipped with relief valves to release any over pressure.</li> <li>• The compressor system is equipped with safety relief valves. Safety switches connected to the overall system PLC, and OSHA standard belt guards.</li> <li>• The storage tanks store compressed hydrogen gas at 6,250 psi. These tubes are also designed to ASME standards with a design pressure of 7,255 psi, and tested to 1.5 times that level. The tanks are equipped with relief valves to release any overpressure.</li> <li>• The two dispensers operate at pressures of 5,000 psi and 3,600 psi respectively. They utilize connectors that include over-pressure protection, remote shutoff capability, a breakaway connector (in case the car is driven away while the fill hose is attached) and non-interchangeable nozzles (to prevent inadvertent use of a 5,000 psi dispenser with a car designed with a 3,600 psi tank).</li> </ul>
Process	<ul style="list-style-type: none"> <li>• The entire refueling system is designed for unattended operation for extended periods and can be monitored locally via a PC. The system is designed for fail safe shutdown and is provided with an emergency stop button and a remote shutdown contact. The unit can also be shutdown via the PLC. The system includes redundant combustibles detectors, a CO monitor and a fire detection system.</li> <li>• Dispensing follows the CA Fuel Cell Partnership (CaFCP) protocol for vehicle fueling including communication with the vehicle and dispenser.</li> </ul>
Site	<ul style="list-style-type: none"> <li>• In the absence of a forced ventilation enclosure, all equipment located in the hydrogen generator room is rated for Class I, Div. 2, Group B service.</li> <li>• The control system is located outside of the hydrogen generator room in a non-hazardous area classification.</li> </ul>

## 4.4 Tube Trailer Documentation

### Process Description

The compressed hydrogen refueling station is comprised of a tube-trailer system. Relatively speaking, the tube-trailer is a simple and low-capital expense way to provide hydrogen fueling for vehicles. Hydrogen gas is stored in the tube trailer, roughly at an operating pressure of 3,200 psig, which feeds the compressor system. After compression, the gas is stored in buffer storage tanks and then dispensed on board the vehicles. The trailer assembly is not a permanent fixture and is refilled off-site. Connections to the trailer utilize a permanent tubing system. A tube trailer consists of a pack of pressurized cylinders connected by a manifold and housed on a trailer.

#### ***4.4.1 Equipment Description***

The tube trailer holds about 343 kg (137,500 scf) of hydrogen at an operating pressure of 3,200 psi. Typical dimensions for the trailer are 40 to 45 feet long, 10 feet high and 8 to 9 feet wide. The hydrogen storage tubes are Type IV DOT and NHTSA certified, with a burst-disc/fusible-metal pressure-relief-device (PRD) providing over pressure protection. This device is screwed directly into the bottle with a vent line that directs vented gas to a safe location.

Table 4-11 summarizes the typical equipment and utility specifications. Table 4-12 is a summary of the codes and standards applicable to compressed hydrogen/tube trailer system. Figures 4-12 through 4-14 show the representative PFD, P&ID, and site plans. Table 4-13 presents a typical station operating procedures and Table 4-14 presents the various safety measures.



**Table 4-11. Tube Trailer and Compressed Hydrogen Equipment and Product Specification**

Item	Specification
Tube Specifications	<ul style="list-style-type: none"> <li>• 38-ft long</li> <li>• 14-inch OD</li> <li>• 0.409-inches minimum wall thickness</li> <li>• 34.2 cu-ft water volume/each</li> <li>• 2,500 lb/each</li> <li>• 3,129 psi maximum allowable pressure</li> <li>• 103,102 scf hydrogen payload @ max. pressure</li> </ul>
Tube Certification	<ul style="list-style-type: none"> <li>• DOT 3T</li> <li>• Type IV</li> </ul>
Piping Systems	In conformance with : <ul style="list-style-type: none"> <li>• ASME B31.8: Gas Transmission &amp; Distribution Piping Systems – for process piping</li> <li>• CGA G-5.4: Standard for Hydrogen Piping Systems at Consumer Location – hydrogen piping</li> </ul>
Equipment and Area Classification	<ul style="list-style-type: none"> <li>• Electrical equipment in conformance with NFPA 70</li> <li>• Class I, Division 2, Group B Service</li> <li>• Explosion proof equipment in open area</li> </ul>
<b>Other Equipment</b>	
Tube Trailer Delivery Truck	<ul style="list-style-type: none"> <li>• 14-ft clearance, 40-ft trailer</li> <li>• Class 8 Tractor</li> </ul>
Hydrogen Compressor	<ul style="list-style-type: none"> <li>• Compression to 6,250 psi</li> <li>• 4 kg/h nominal</li> </ul>
Compressed Hydrogen Storage Vessels	<ul style="list-style-type: none"> <li>• 30 kg H<sub>2</sub> capacity</li> <li>• 1.21 WC m<sup>3</sup> H<sub>2</sub> capacity</li> </ul>
Compressed Hydrogen Dispenser	<ul style="list-style-type: none"> <li>• Fueling at 5,000 and 3,600 psi</li> <li>• Sherex nozzles with three-way valve</li> <li>• Break-away coupling of nozzle</li> </ul>

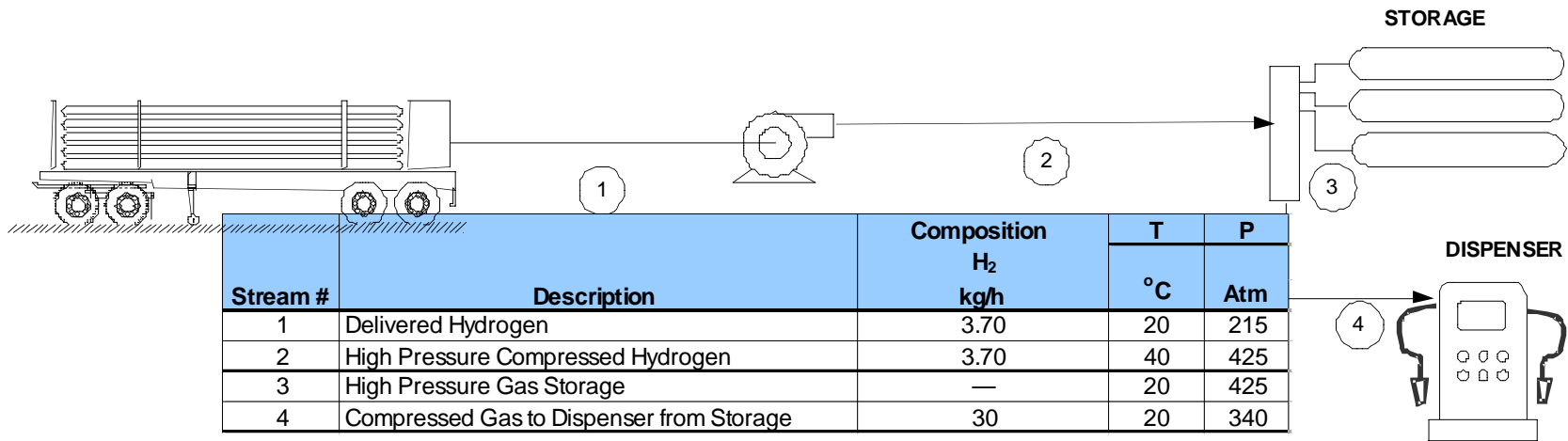
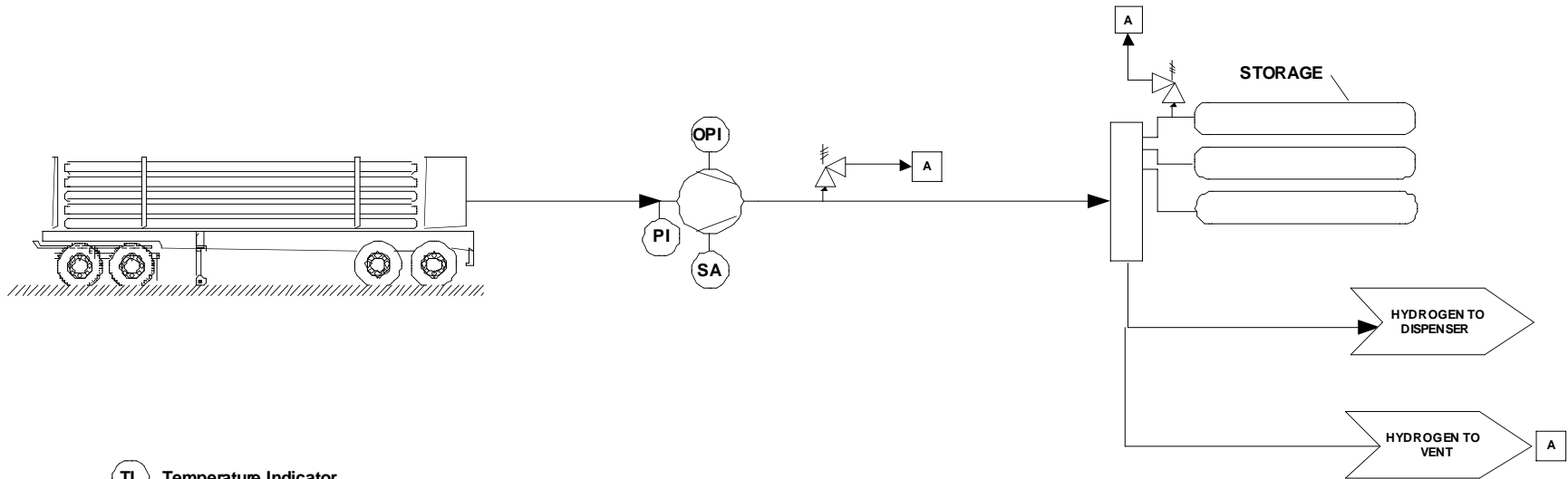









Figure 4-12. Tube Trailer Delivery-Based Refueling Station Process Flow Diagram



-  **TI** Temperature Indicator
-  **H<sub>2</sub>I** Hydrogen Indicator
-  **PI** Pressure Indicator
-  **OPI** Oil Pressure Indicator
-  **SA** Seal Failure Alarm
-  Pressure Relief Valve
-  Rupture Disk
-  Hydrostatic Relief Valve

Property of: TIAX LLC 1061 De Anza Blvd. Cupertino, CA 95014	<b>Piping and Instrumentation Diagram</b>			
	<b>Hydrogen Fueling Station - Tube Trailer Delivery, Compressed Hydrogen</b>			
<b>PROPRIETARY INFORMATION</b>	SIZE	DWG BY	DWG NO	REV
	B	John Woody	D130-P-4001	1a
	SCALE	Not to Scale	07/24/03	SHEET 1 OF 1

**Figure 4-13. Piping and Instrumentation Diagram for Tube Trailer Delivery-Based Refueling**

**Table 4-12. Codes and Standards Regarding Compressed Hydrogen Storage**

Element of Station	Distance from Gaseous Hydrogen Storage		
	NFPA 50A	IFGC 704.2	IFC 2209.3.1.1
Walls with minimum fire rating	5 ft (2-hour)	—	—
Wall openings (doors & windows)	25 ft	—	—
Intake vents	50 ft	—	—
Lot Line	5 ft	10 ft	15 ft
Places of public assembly	50 ft	—	—
Parked vehicles	15 ft	—	—
Gasoline Storage	50 ft	—	—
Overhead Electric Wire	—	5 ft	0 ft
Cement Block Wall	0 ft	0 ft	5 ft
Public sidewalks	15 ft	10 ft	15 ft
Overhead Trolley Bus Wire	—	50 ft	—
Office/Store	—	—	—
Building having noncombustible wall surfaces that are not part of a 1 hour fire resistant-rated assembly	—	—	25 ft
Ignition Source	25-50 ft 0 ft w/ 2-hour wall	10 ft	25 ft
Gasoline and Hydrogen Dispensing	—	10 ft	15 ft
Office/Store	—	10 ft	15 ft
HVAC, doors, and windows	—	—	15 ft

**Compressed Hydrogen Delivery-Based Refueling Station Site Plan**

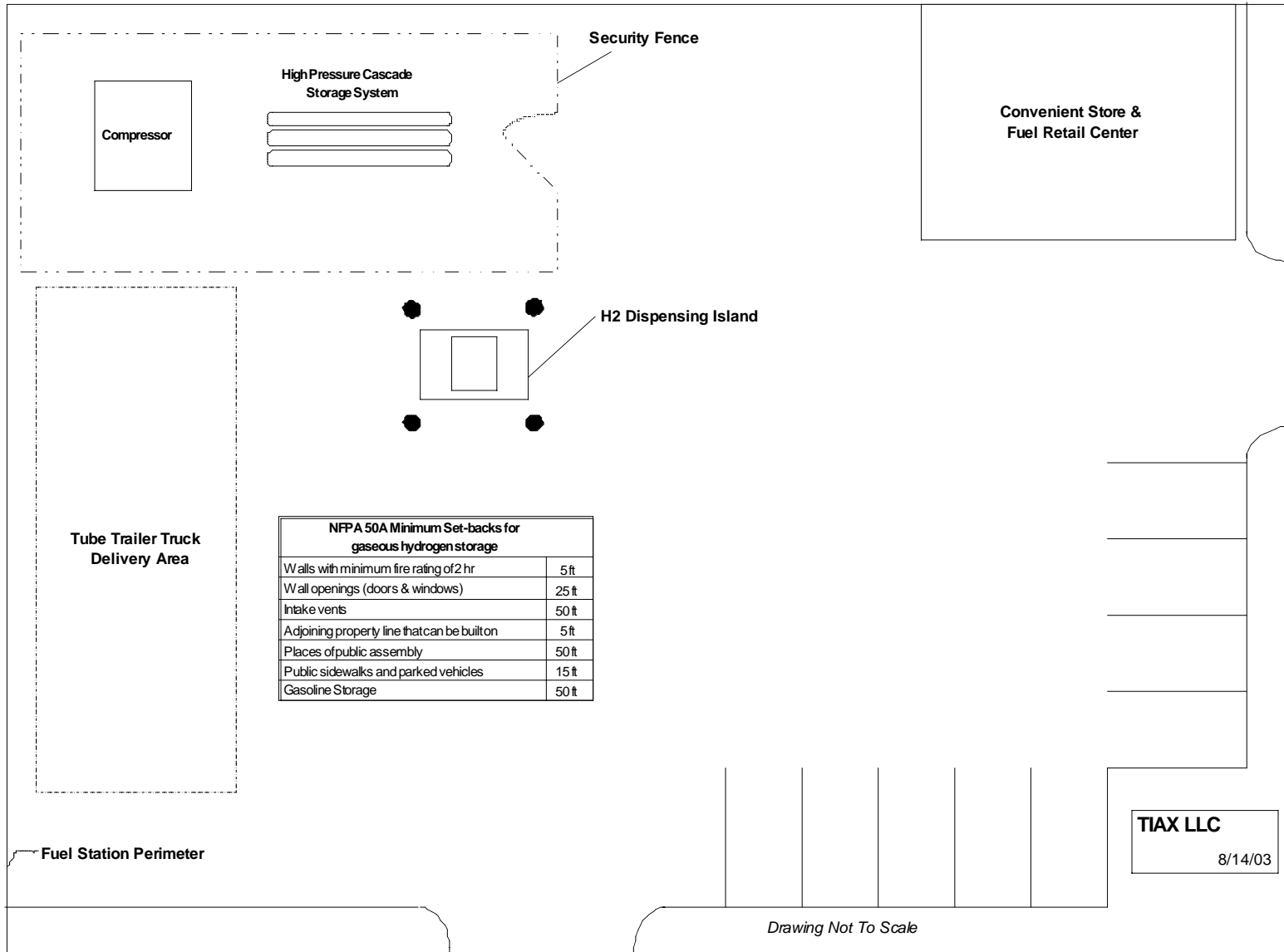

A-24

**Figure 4-14. Compressed Hydrogen Delivery-Based Refueling Station Site Plan**

**Table 4-13. Tube Trailer Delivery-Based Refueling Station Operating Procedures**

Step	Key Equipment Involved	Example Operating Sequences
1. System Startup & Operation	<ul style="list-style-type: none"> <li>• Tube-Trailer</li> <li>• High Pressure Hydrogen Storage</li> <li>• Compressor</li> </ul>	<p>Initiate following start-up sequence using a computerized SCADA system – Turn “ON” switch to result in the following actions</p> <ol style="list-style-type: none"> <li>1. Turn system power on.</li> <li>2. When high-pressure storage bank pressure falls below set-point pressure (~ 6,200 psi), open tube-trailer storage system main outlet valve.</li> <li>3. Start compressor and fill up high-pressure storage bank to set-point pressure.</li> <li>4. Stop compressor after set-point pressure is reached.</li> <li>5. Close main outlet valve of step 1.</li> </ol>
2. System Shutdown	<ul style="list-style-type: none"> <li>• Tube-Trailer</li> <li>• High Pressure Hydrogen Storage</li> <li>• Compressor</li> </ul>	<p>Initiate following start-up sequence using a computerized SCADA system. Turn “OFF” switch to result in the following actions:</p> <ol style="list-style-type: none"> <li>6. All distribution valves to normally-close position.</li> <li>7. Turn system power off.</li> </ol>
3. Dispensing/Vehicle Refueling	<ul style="list-style-type: none"> <li>• Dispenser</li> <li>• Vehicle</li> </ul>	<ul style="list-style-type: none"> <li>• Dispensing follows the CA FCP protocol for vehicle fueling including communication with the vehicle and dispenser.</li> <li>• Dispenser is activated with a card-lock/PIN mechanism</li> <li>• Following connection of the hose with the correct receptacle (5,000-psi vs. 3,600-psi) fueling commences.</li> <li>• When fueling is complete, dispenser is turned off. The receptacle release lever also serves to vent fugitive gas back to the dispenser.</li> </ul>

**Table 4-14. Tube Trailer Delivery-Based Refueling Station Safety Measures**

Safety	Example Measures
Equipment	<ul style="list-style-type: none"> <li>• The tube-trailer is designed to DOT 3T Type IV and NHTSA standards. The tubes on the trailer are secured on an ASME receiver assembly.</li> <li>• The high-pressure compressor system is equipped with safety relief valves, safety switches connected to the overall system PLC, and OSHA standard belt guards.</li> <li>• The storage tanks store compressed hydrogen gas at 6,250 psi. These tubes are also designed to ASME standards with a design pressure of 7,255 psi, and tested to 1.5 times that level. The tanks are equipped with relief valves to release any overpressure.</li> <li>• The two dispensers operate at pressures of 5,000 psi and 3,600 psi respectively. They utilize connectors that include over-pressure protection, remote shutoff capability, a breakaway connector (in case the car is driven away while the fill hose is attached) and non-interchangeable nozzles (to prevent inadvertent use of a 5,000 psi dispenser with a car designed with a 3,600 psi tank).</li> </ul>
Process	<ul style="list-style-type: none"> <li>• Maintenance activities follow OSHA 1910.147 lock-out tag-out procedures.</li> <li>• The entire refueling system is designed for unattended operation for extended periods and can be monitored locally via a PC. The system is designed for fail safe shutdown and is provided with an emergency stop button and a remote shutdown contact. The unit can also be shutdown via the PLC. The system includes redundant combustibles detectors, a CO monitor and a fire detection system.</li> <li>• Dispensing follows the CAFCP protocol for vehicle fueling including communication with the vehicle and dispenser.</li> </ul>
Site	<ul style="list-style-type: none"> <li>• In the absence of a forced ventilation enclosure, all equipment located in the hydrogen generator room is rated for Class I, Div. 2, Group B service.</li> <li>• The control system is located outside of the hydrogen generator room in a non-hazardous area classification.</li> </ul>

## 4.5 Compressed Natural Gas (CNG) Documentation

### 4.5.1 Natural Gas Refueling Station Major Components

#### Production/Delivery

Pipeline natural gas is delivered at three to 40 psig. The available gas pressure varies with each site. Higher supply pressures will enable using a compressor with one less stage and lower power requirements. Natural gas supply pressures as high as 200 psi may be available at some industrial sites. Prior to compression, a dryer removes moisture and heavy hydrocarbons.

### 4.5.2 Refueling Station Nominal Design Basis

**Table 4-15. CNG Fueling Station Common Design Bases**

Number of vehicles refueled	10 per day
Number of vehicles per hour	5 per 2-hours
Vehicle refueling capacity	7.4 therms-CNG/fill (743 scf/fill)
Vehicle refueling time	10 min/vehicle
Station maximum average consumption	7430 scf-CNG/day

The assumed energy consumption (in Btu/mile) of the CNG vehicles is roughly twice that of an identical hydrogen fuel cell vehicle. The relationship between CNG and hydrogen vehicle energy consumption would be different for dissimilar vehicle or power plant configurations.

## CNG Compression

### Equipment Description

The power required for CNG compression depends on the compressor inlet and exit pressure, compressor configuration, and motor. A 4-stage reciprocating compressor, intercooled, lubricated, 4,500-psi discharge pressure, 600 scfh, 200-hp electric motor driven compressor is specified for use at this site. The compressor is located outside. Enclosure mounted compressor systems are also used in the CNG industry but were not assumed for this configuration. The configuration of the CNG system is similar to the hydrogen tube trailer discussed in Section 4.4.



## **High Pressure CNG Storage**

### **Process Description**

All CNG fueling stations include some form of high-pressure gas storage prior to the dispenser. This storage is either a buffer or cascaded pressure vessel(s), and its capacity can range from small to large.

### **Equipment Description**

A bank of two high-pressure storage vessels with a total capacity of 200 therms of CNG is specified.

## **High Pressure CNG Dispensing System**

### **Process Description**

The dispenser draws from the high-pressure gas storage system described in the previous section. The controller for the cascade, which is called a priority-sequencing controller, is part of the dispenser. The priority sequencing controller has fully programmable set points for directing the gas supply from the different banks (i.e., at a common pressure) of storage vessels to the dispenser. The set points for switching the gas supply from different banks of storage vessels are selected to suit fueling requirements such as the quantity of CNG to be dispensed. A heat-of-compression algorithm is used by the dispenser to predict the quantity of gas to be dispensed into the fuel tank that will provide a full fill, or the fullest possible fill, within tank pressure and temperature constraints. The fueling nozzles have a lever that actuates a three-way valve that allows gas (that would otherwise be trapped at the end of the fill) to be vented back to the dispenser through a vent hose.

### **Equipment Description**

For this specific site, the dispenser is equipped with 3,600 psi nozzles. Fill hoses are reinforced and rated for high-pressure CNG service. The hose is connected to the dispenser by a break-away device. This coupling is designed to prevent natural gas release in case a vehicle drives away from the dispenser with the nozzle still connected to the receptacle. The break-away device disconnects when subjected to relatively low tensile loads or bending moments. Poppet valves in each segment spring close to stop the natural gas flow. Access to a CNG dispenser is controlled by a card lock system with PIN access.

Table 4-16 summarizes the typical equipment and utility specifications. Table 4-17 is a summary of the codes and standards applicable to CNG station. Figures 4-15 through 4-17 show the representative PFD, P&ID, and site plans.

**Table 4-16. Compressed Natural Gas Equipment and Product Specification**

Item	Specification
System Power Supply	<ul style="list-style-type: none"> <li>• 480 V, 3-Phase, 60 HZ</li> <li>• Power 325 kVA</li> </ul>
Natural Gas Feed Line	<ul style="list-style-type: none"> <li>• Delivery at 3-40 psi</li> </ul>
Natural Gas Compressor	<ul style="list-style-type: none"> <li>• Compression to 4,500 psi</li> <li>• 2.5 kg/h flowrate</li> <li>• Explosion proof equipment in open area</li> </ul>
Compressed Natural Gas Storage Vessels	<ul style="list-style-type: none"> <li>• 20,000 scf of natural gas capacity</li> <li>• 4,500 psig</li> <li>• 144 kg CH<sub>4</sub> capacity</li> <li>• 14.4 WC m<sup>3</sup> CH<sub>4</sub> capacity</li> </ul>
Compressed Natural Gas Dispenser	<ul style="list-style-type: none"> <li>• Fueling at 3,000 and 3,600 psi</li> <li>• Sherex nozzles with three-way valve</li> <li>• Break-away coupling of nozzle</li> </ul>

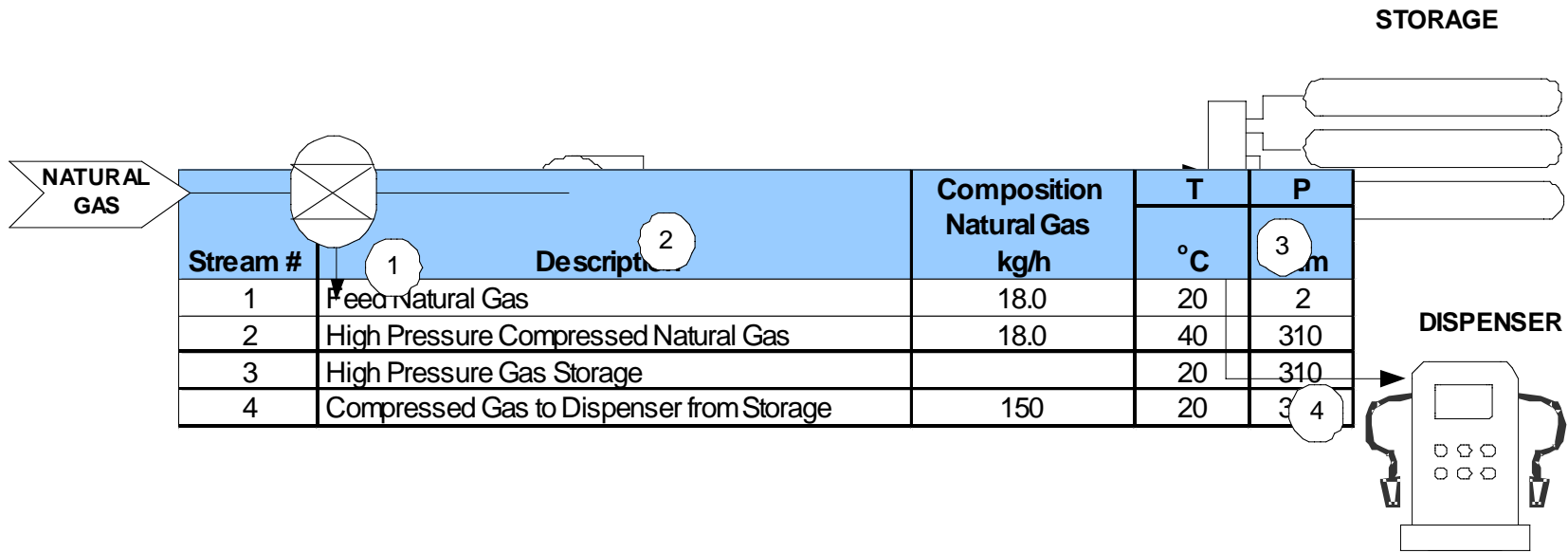

A-27

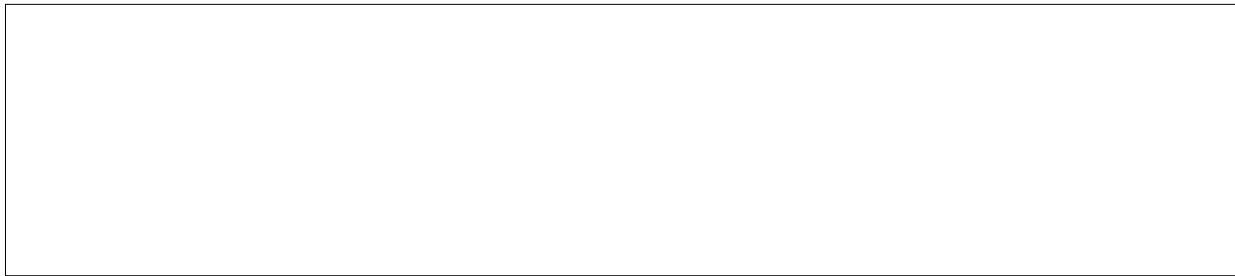
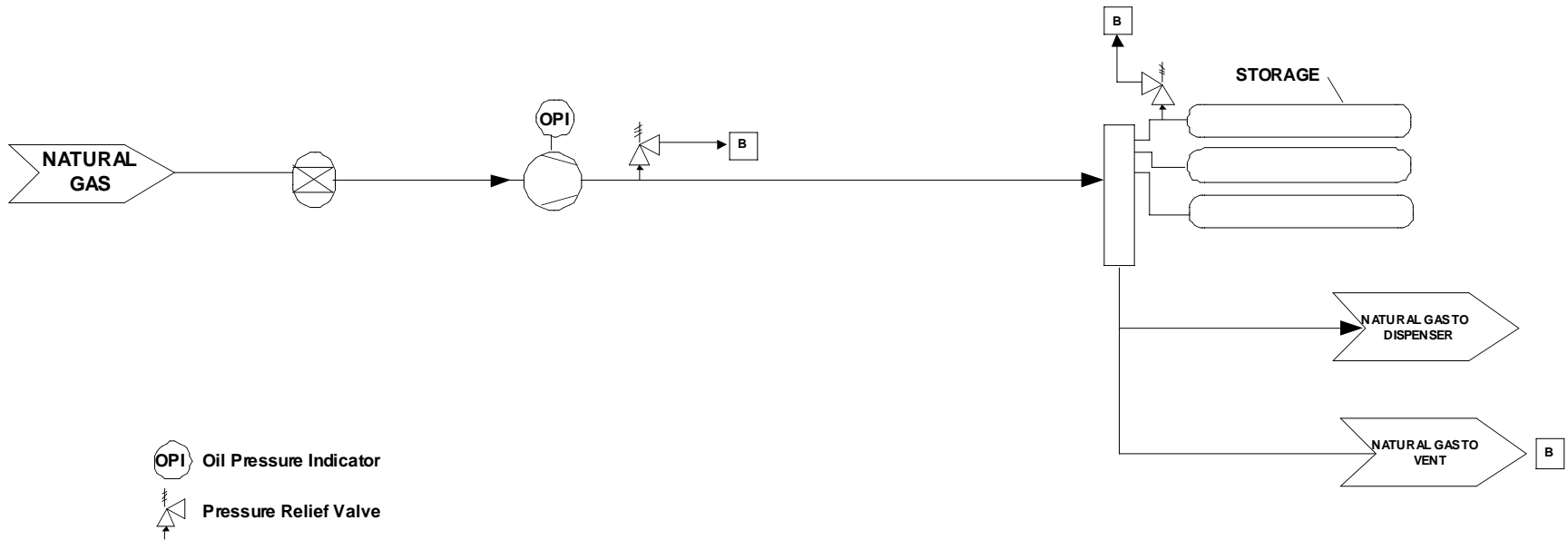



Figure 4-15. Compressed Natural Gas Refueling Station Process Flow Diagram



 Oil Pressure Indicator  
 Pressure Relief Valve

Property of: TIAX LLC 1061 De Anza Blvd. Cupertino, CA 95014	<b>Piping and Instrumentation Diagram</b>			
	<b>Compressed Natural Gas Station - CNG Delivery via Pipeline</b>			
<b>PROPRIETARY INFORMATION</b>	SIZE B	DWG BY John Woody	DWG NO D130-P-5001	REV 1a
	SCALE Not to Scale	07/24/03	SHEET 1 OF 1	

**Figure 4-16. Piping and Instrumentation Diagram for Compressed Natural Gas Refueling**

**Table 4-17. Codes and Standards Regarding Compressed Natural Gas Storage**

<b>Element of Station</b>	<b>Distance from Gaseous Natural Gas Storage</b>
	<b>NFPA 52</b>
Point of Transfer	3 ft
Lot Line	10 ft
Gasoline Storage	20 ft
Public sidewalks or streets	10 ft
Railroad Track	50 ft
Readily Ignitable Material	10 ft
Ignition Source	10 ft

### Compressed Natural Gas Refueling Station Site Plan

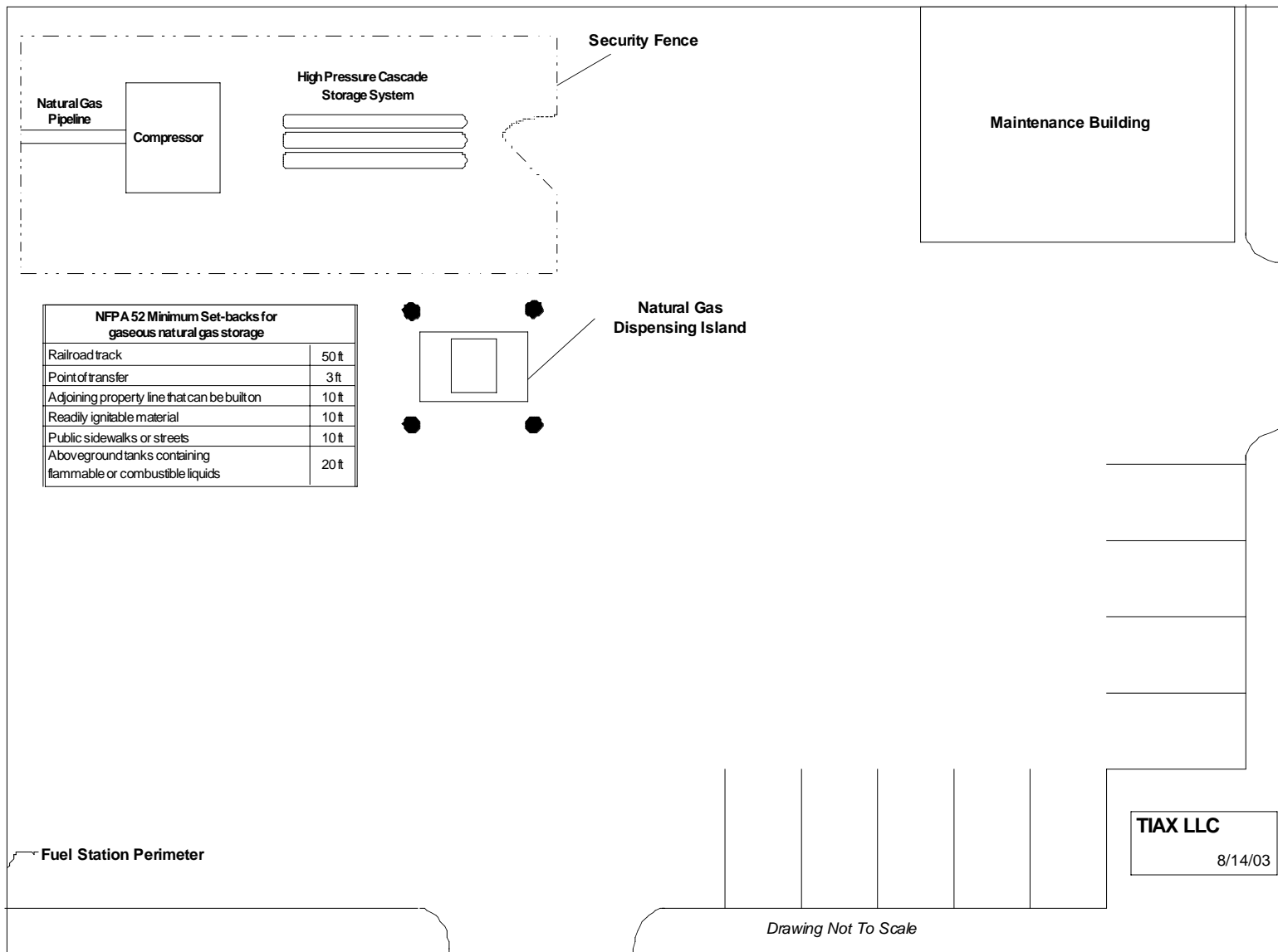

Figure 4-17. Compressed Natural Gas Refueling Station Site Plan

# 5. COMPARISON OF HYDROGEN AND OTHER FUELS

## 5.1 Introduction

The question of whether hydrogen is safer or more dangerous than gasoline, diesel, or other fuels does not have a simple answer for the following reasons:

- The relative safety of different fuels is highly scenario dependent. Fuel leaks from a high-pressure fitting in a closed garage with an overhead garage-door opener are more likely to be an issue for hydrogen than for gasoline. Carbon monoxide poisoning can be an issue for gasoline and other fuels but not for hydrogen. We can apply scientific methods such as failure modes and effects analysis (FMEA) to predict the frequency and consequences associated with using different fuels in different scenarios. The difficult part is quantifying the relative frequency of completely different scenarios.
- Because hydrogen use as an automotive fuel is in its infancy, we simply cannot compare hydrogen and gasoline vehicle accident statistics. Even when hydrogen vehicle accident data do become available, work with gasoline vehicle accident data shows that it is often not straightforward to segregate accidents where the fuel did or did not play a role in the accident cause or effect (e.g., accident reports from many states do not note if the vehicle caught fire). While there are historical data pertaining to hydrogen use in industrial, aerospace, and other applications, the application of these data to hydrogen-fueled vehicles is questionable.
- The newness of hydrogen fuel use renders judgment problematic when considering the specific vehicle and fueling station design features affecting potential accidents. What types of safety features will hydrogen vehicles and fueling stations have? Various groups are working to develop codes and standards that will eventually answer this question.

While it is not possible to rank the absolute overall safety of hydrogen-fueled vehicles at this time, it is possible to compare the general safety issues associated with hydrogen and other fuels. General safety concerns derive primarily from the different physical and chemical properties of different fuels and from the scenarios for which these properties might make an accident more likely. The following sections compare the properties of hydrogen with other fuels. This provides the basis for the discussion of the different safety issues associated with these fuels.

## 5.2 Hydrogen Properties

Table 5-1 lists some of the key chemical and physical properties of hydrogen and six other fuels: natural gas, liquefied petroleum gas (LPG), methanol, ethanol, gasoline, and diesel fuel. Table 5-1 presents data abstracted from many sources (DOE AFDC, Kirk, NASA 1997, Murphy, Browning, AGA 1981, Perry, and Peschka). This fuel property comparison provides a basis for discussing the different safety issues associated with different fuels and the circumstances in which hydrogen is likely to be safer or less safe than other fuels.

The data in Table 5-1 should be interpreted and used with caution. The notes to Table 5-1 list some important caveats. A factor that makes such fuel property comparisons ambiguous is that some of the fuels are imprecisely defined. While hydrogen is generally regarded as nearly pure hydrogen, particularly if it is used for fuel cell vehicles, the definitions of the other fuels are not as simple. Gasoline and diesel fuel are designations applied to fuels that can have a range of compositions depending on geographic location, season, applicable regulations, grade (e.g., octane rating), and manufacturer. Natural gas and LPG compositions also vary significantly, and the composition of CNG is usually different from LNG, which contains essentially no carbon dioxide, water vapor, or sulfur compounds. Table 5-1 lists gasoline and diesel fuel properties for typical compositions, and some fuel blends can have properties that depart significantly from these values. Natural gas and LPG are assumed to consist of 100 percent methane and propane, respectively, in order to avoid the need to arbitrarily define “typical” compositions. Methanol and ethanol are assumed to be pure “neat” alcohols, sometimes referred to as M100 and E100, respectively.

The basic thermodynamic properties of pure compounds (e.g., the critical temperature and pressure of hydrogen or methane) are usually measured and reported with high accuracy. Different literature sources often cite significantly different values of other properties such as flammability limits or minimum ignition energy. This is because subtle differences among the experiments produced these measurements.

A final fuel property comparison challenge arises for fuels such as hydrogen and natural gas that are commonly stored at different conditions, such as compressed or liquefied. Properties that are mass-based (e.g., lower heating value or LHV) are unaffected, but other properties including density obviously depend on the storage condition. For hydrogen and natural gas, Table 5-1 includes density and LHV x density (e.g., heating value per unit storage volume) for typical compressed and liquefied storage conditions.



**Table 5-1. Properties of Hydrogen and Other Current and Potential Automotive Fuels<sup>25</sup>**

Fuel	Units	Hydrogen	Natural Gas (methane <sup>2</sup> )	LPG (propane <sup>3</sup> )	Methanol	Ethanol	Gasoline <sup>4</sup>	Diesel Fuel <sup>5</sup>
Chemical composition	—	H <sub>2</sub>	CH <sub>4</sub>	C <sub>3</sub> H <sub>8</sub>	CH <sub>3</sub> OH	C <sub>2</sub> H <sub>5</sub> OH	Hydrocarbon mixture	Hydrocarbon mixture
Molecular weight	—	2.016	16.04	44.09	32.04	46.07	~105 avg.	~200 avg.
Carbon hydrogen ratio	(atom ratio)	0	0.25	0.375	0.25	0.333	0.54	0.56
Critical temperature	°C	-240	-82	97	240	243	—	—
Critical pressure	kPa	1,290	4,600	4,250	7,970	6,390	—	—
Phase at NPT	—	gas	gas	gas	liquid <sup>6</sup>	liquid <sup>6</sup>	liquid <sup>6</sup>	liquid <sup>6</sup>
Density at NPT	kg/m <sup>3</sup>	0.080	0.680	1.86	795 <sup>8</sup> /1.35 <sup>9</sup>	790 <sup>8</sup> /1.94 <sup>9</sup>	752 <sup>8</sup> /2.88 <sup>9</sup>	857 <sup>8</sup> /5.50 <sup>9</sup>
Boiling temperature at 1 atm	°C	-253	-162	-42	65	78	27-225	187-343
Reid vapor pressure (RVP)	kPa	N/A	N/A	N/A	32	15	62	0.15
Lower heating value (LHV)	kJ/kg	120,000	50,000	46,300	20,000	27,000	44,000	42,600
Octane rating <sup>7</sup>	—	(ambiguous)	120	105	100	100	86-94	low
Cetane rating	—	low	low	low	low	low	low	40-55
Heat of vaporization	kJ/kg	446	509	448	1,170	921	340	260
Stoichiometric combustion in air	air/fuel volume ratio	2.4	9.5	23.8	7.2	14.3	55	85
Flame temperature <sup>1</sup>	°C	2,045	1,877	1,980	1,871	1,920	2,027	1,993
Lower flammability unit (LFL)	vol. % in air	4.1 <sup>10</sup>	5.0	2.2	6.6	3.3	1.4	0.6
Upper flammability limit (UFL)	vol. % in air	75	15	9.5	37	19	7.6	6
Flash point	°C	N/A	N/A	N/A	11	13	-43	70
Minimum ignition energy	MJ	0.02	0.29	0.25	0.14	0.20	0.24	0.30
Autoignition temperature	°C	575	540	480	450	380	260	280
Burning velocity at NPT <sup>1</sup>	m/sec	3.0	0.36	0.40	0.46		0.35	
Diffusion coefficient at NPT	cm <sup>2</sup> /sec	0.61	0.16		0.14	0.10	0.06	0.05
Flame visibility in sunlight	—	none	medium	medium	low	low	high	high
Odor	—	none	None <sup>12</sup>	none <sup>12</sup>	yes	yes	yes	yes
Taste	—	none	none	none	none <sup>13</sup>	none <sup>13</sup>	yes	yes
Toxicity	—	none <sup>11</sup>	None <sup>11</sup>	none <sup>11</sup>	posionous <sup>13</sup>	intoxicating <sup>13</sup>	yes <sup>14</sup>	yes <sup>14</sup>
Typical vehicle storage modes	— —	Compressed (CH <sub>2</sub> ) <sup>15</sup> Liquefied (LH <sub>2</sub> ) <sup>16</sup>	Compressed (CNG) <sup>17</sup> Liquefied (LNG) <sup>12</sup>	Compressed <sup>19</sup>	Liquid at ambient P&T	Liquid at ambient P&T	Liquid at ambient P&T	Liquid at ambient P&T
Density for typical storage modes	kg/m <sup>3</sup> kg/m <sup>3</sup>	CH <sub>2</sub> : 23.8 <sup>20</sup> LH <sub>2</sub> : 66.6 <sup>21</sup>	CNG: 205 <sup>22</sup> LNG: 384 <sup>23</sup>	508 <sup>24</sup>	795	790	752	857
LHV x density for typical storage modes	MJ/m <sup>3</sup> MJ/m <sup>3</sup>	CH <sub>2</sub> : 2,760 <sup>20</sup> LH <sub>2</sub> : 7,990 <sup>21</sup>	CNG: 10,250 <sup>22</sup> LNG: 19,200 <sup>23</sup>	23,520 <sup>24</sup>	15,900	21,330	33,100	36,500

## Notes to Table 5-1

1. Properties of stoichiometric fuel-air mixture.
2. Natural gas is a mixture of methane plus small but variable amounts of other light hydrocarbons, nitrogen, carbon dioxide, water vapor, and other gases. Natural gas is characterized here as 100% methane in order to provide unambiguous properties.
3. LPG (liquid petroleum gas) used as a motor vehicle fuel is usually consistent with specifications that limit the concentrations of non-propane constituents such as butane and propylene. LPG is characterized here as 100% propane in order to provide unambiguous properties.
4. Gasoline is a mixture of hydrocarbons plus small quantities of other constituents with variable compositions depending on location, season, prevailing regulations, and refiner. Properties shown are approximately typical averages or ranges.
5. Diesel fuel a mixture of hydrocarbons plus small quantities of other constituents with variable compositions depending on location, season, prevailing regulations, and refiner. Properties shown are approximately typical averages or ranges.
6. Liquid with low vapor pressure; see density and RVP properties.
7. Octane rating shown = (Research Octane No. + Motor Octane No.)/2. Note that there is ambiguity with respect to octane rating definitions when octane rating >100, and so these values should be regarded as very approximate.
8. Liquid density at NPT = 15.5°C (60°F) and 101.56 kPa (14.73 psi), as defined by American Gas Association.
9. Approximate density of fuel vapors saturated at NPT.
10. Recent tests indicate that hydrogen's LFL is 4.1% only under special circumstances, and it is somewhat higher in most practical situations.
11. These gaseous fuels are nontoxic, but they can cause asphyxiation if their concentration is high enough to displace significant oxygen.
12. Odorants are added to natural gas and LPG in many applications so that leaks are detectable by smell.
13. Taste deterrents (denaturants) are often added to methanol because of its toxicity and to ethanol to ensure that alcoholic beverages are appropriately taxed.
14. Some gasoline and diesel fuel components are carcinogenic.
15. Compressed hydrogen is typically stored at 24.8 MPa (3,600 psi) or 34.5 Mpa (5,000 psi).
16. Liquid hydrogen is typically stored saturated at -250°C (-418°F).
17. CNG is typically stored at 20.7 MPa (3,000 psi) or 24.8 MPa (3,600 psi).
18. LNG is typically stored saturated at -134°C (-210°F).
19. Propane liquefies when compressed at ambient temperatures and is typically stored saturated at 0.63 MPa (92 psig) and 15.6°C (60°F).
20. At 34.5 MPa (6,000 psi).
21. At -250°C (-418°F).
22. At 24.8 MPa (3,600 psi).
23. At -134°C (-210°F).
24. Saturated at 15.6°C (60°F).
25. Data sources: DOE AFDC, Kirk, NASA 1997, Murphy, Browning, AGA 1981, Perry, and Peschka

## 5.3 Fuel Property Comparisons and Implications

This section highlights a few of hydrogen's unique properties that affect risk and safety issues when it is used as an automotive fuel. Section 5.4 makes a direct comparison of hydrogen with natural gas and Section 5.5 summarizes some general ways in which hydrogen may be more or less safe than other automotive fuels.

### 5.3.1 Properties Affecting Leakage

Because hydrogen is stored at high pressures or cryogenic temperatures, and because the hydrogen molecule is so small, hydrogen is more leak prone than other fuels. Hydrogen can leak through air-tight seals and escape from systems that have tested leak-free with gases such as nitrogen (Rosen).

While hydrogen's low molecular weight makes it more leak-prone, its exceptionally high sound speed and low viscosity cause hydrogen leaks through a given-size opening to have a much higher velocity and volumetric flow rate relative to other gaseous or liquid fuels<sup>8</sup>. However, because of hydrogen's low density, the mass flow rate of hydrogen through a given-size leak opening will be less than that of other fuels.

### 5.3.2 Buoyancy

Because of its low critical temperature and low molecular weight, hydrogen is a gas when warmer than  $-253^{\circ}\text{C}$  at atmospheric pressure, and is less dense than any other gas at the same temperature and pressure. Therefore, hydrogen is highly buoyant. Figure 5-1 shows hydrogen's buoyancy (defined here as simply  $1/\text{density}$ ) compared with other fuels listed in Table 5-1 and also compared to air buoyancy.

Hydrogen's extraordinary buoyancy has substantial safety implications. Hydrogen rises very rapidly. Even when considering hydrogen's high diffusion coefficient, hydrogen plumes do not spread horizontally very far (e.g., compared with natural gas or propane) before the concentration decreases below LFL. This is because the vertical movement and mixing is so rapid. In many outside vehicle situations, hydrogen's buoyancy makes it a relatively safe fuel; however, hydrogen leaks inside enclosed structures with overhead ignition sources are dangerous.

<sup>8</sup> The flow velocity of leaks induced by a high pressure differential so that the flow is choked depends on the fluid sonic velocity. The flow velocity of leaks induced by low pressure differentials depends on the fluid viscosity.

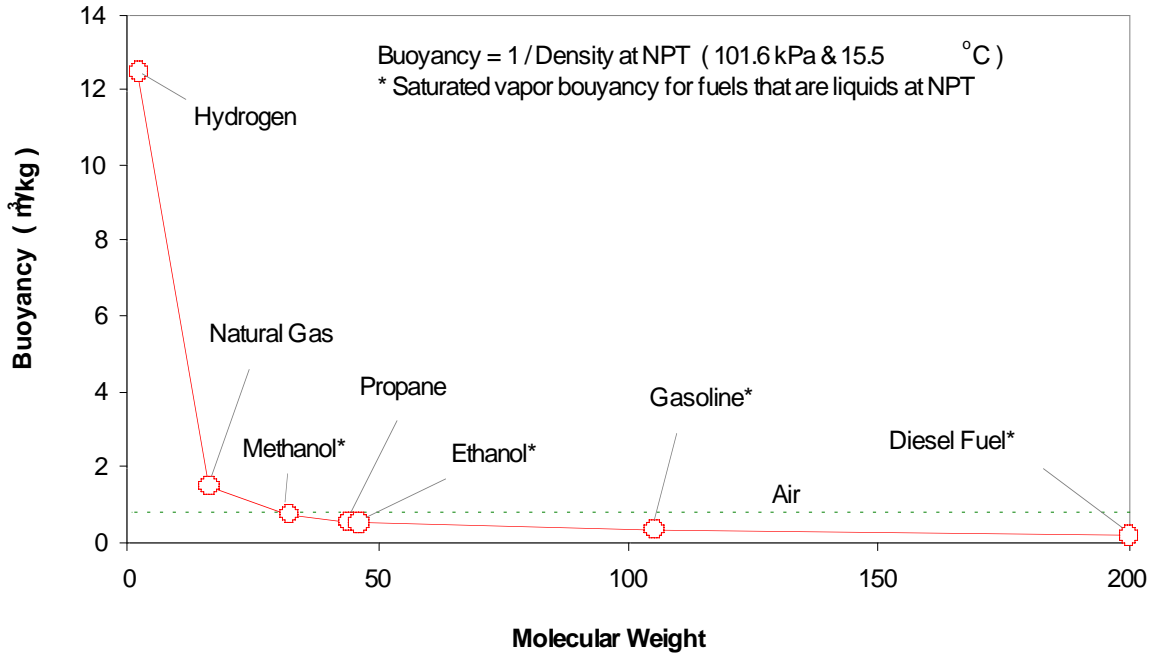

**Figure 5-1. Hydrogen is Substantially More Buoyant than Air and Other Current and Potential Automotive Fuels**

Leaked liquid hydrogen disperses relatively quickly. While liquid hydrogen is heavier than air, hydrogen vapor becomes more buoyant than ambient air at about  $-250^{\circ}\text{C}$ . This compares to natural gas, which becomes more buoyant than air at about  $-107^{\circ}\text{C}$ <sup>9</sup>. As a result, large LNG spills are much more prone to forming dangerous ground-hugging clouds than equivalent-quantity liquid hydrogen spills. NASA reported that spills of 500 gallons of liquid hydrogen in an unconfined area will diffuse to a nonexplosive mixture concentration in about one minute (Rosen).

### 5.3.3 Flammability Limits and Ignition Energy

Table 5-1 indicates that hydrogen has relatively wide flammability limits in air, which are usually cited in the literature as approximately four percent (LFL) to 75 percent (UFL); however, flammability and explosive limits are highly dependent on pressure, temperature, and diluents, and especially on the details of the hydrogen-air mixture and ignition source interaction. For example, recent experiments at the University of Miami have shown that, while a strong ignition source can produce a small upward-propagating “pencil” of flame in a 4.1 percent hydrogen-in-air mixture, all of the hydrogen is not combusted until the concentration reaches about 10 percent (Swain).

<sup>9</sup> The buoyancy of a cryogenic gas plume is also affected by mixing with and heat transfer to the surrounding air.

The energy required to ignite a near stoichiometric hydrogen-air mixture is extremely low, (usually cited as 0.02 mJ), but it increases near the flammability limits. There are many literature accounts (e.g., Zalosh) of accidental hydrogen leaks igniting for no apparent reason. It is usually assumed that these were caused by small static electricity discharges. Interestingly, while hydrogen's minimum ignition energy is quite low, its autoignition temperature (approximately 575°C) is the highest of any of the fuels listed in Table 5-1.

Hydrogen's wide flammability limits and low ignition energy can actually enhance safety in certain situations. For example, if a small leak ignites immediately, in some cases a small diffusion flame will form that does not ignite or damage any nearby materials. If such a leak is in an enclosure and does not ignite immediately, a large-volume flammable mixture may accumulate so subsequent ignition results in substantial energy release and damage.

### **5.3.4 Burning Velocity**

Combustion of a premixed volume of fuel in air can occur as a deflagration or detonation. While a precise definition of these terms is beyond the scope of this review (see e.g., Strehlow), the flame front propagation is subsonic for a deflagration and supersonic for a detonation. While both forms of combustion are often regarded as an "explosion", only detonations produce the overpressures associated with a shock wave.

Hydrogen's high burning velocity in air makes deflagrations more dangerous, and it makes always-dangerous detonations more probable (e.g., compared to methane-air combustion). Danger in this context refers to damage potential. Higher burning velocities produce rapid pressure rises, which limit the effectiveness of damage-control means such as explosion venting (e.g., blow-out panels).

Depending on the mixture ratio, mixture volume, ignition source, and especially the degree of confinement, hydrogen-air burning can proceed as a deflagration, detonation, or deflagration that progresses to a detonation. In a confined space, a hydrogen-air deflagration can increase the pressure by a factor of about seven, but a detonation can increase the pressure by a factor of about 20 (Rosen). In summary, compared with most other fuels, hydrogen-air mixtures are much more easily ignited, and ignited mixtures are more likely to develop into detonations.

### **5.3.5 Heating Value**

Hydrogen has a higher heating value per unit mass (LHV = 120,000 kJ/kg) than any other candidate automotive fuel. Yet, because hydrogen's density is so low, it has a relatively low heating value per unit volume at atmospheric pressure when compressed and liquefied. This is why it is challenging to store hydrogen in motor vehicles.

In many situations, the volume of air or fuel-air mixture is the limiting factor. This is the case for internal combustion engines where power is limited by air processing capacity and not fuel processing capacity. This is also the case for most accidental deflagrations or detonations. Consider the simplified example of fuel leaking slowly into an enclosed structure, so that the concentration is essentially uniform within the structure at one atmosphere (i.e., the time scale is such that the gas has diffused and mixed so that concentration gradients are negligible). If there is a constant ignition source inside the structure, combustion will start when the mixture reaches the lower flammability limit (LFL), and the energy release will be the product of the fuel volumetric heating value times LFL times structure volume. The maximum energy release corresponding to this hypothetical case occurs when the mixture ignites just as it reaches its stoichiometric ratio. If ignition occurs when the mixture is richer, less energy is released. This is because there is inadequate air to react with the fuel, but the excess fuel could burn subsequently if it mixes with air outside the collapsed structure.

Table 5-2 compares the energy released in a hypothetical 85-m<sup>3</sup> (3,000-ft<sup>3</sup>) residential garage with fully mixed hydrogen or methane at their respective LFLs and stoichiometric ratios.

**Table 5-2. Energy Release Following Ignition of Hypothetical Uniform Fuel-Air Mixtures in an 85-m<sup>3</sup> Garage**

	Energy Released (kJ) for:	
	Hydrogen	Methane
If ignition at LFL	33	145
If ignition at stoichiometric	240	275

### 5.3.6 Detectability

While hydrogen is relatively leak prone, hydrogen leaks and flames are both difficult to detect. Hydrogen leak detectors can be based on principles such as catalytic combustion, absorption in hydrides such as palladium (which produces a temperature rise), hydrogen's very high thermal conductivity, or the difference between hydrogen's and air's index of refraction. The challenge associated with many of these leak detectors is the possibility that they themselves could become an ignition source, and this is exacerbated by hydrogen's low ignition energy and wide flammability limits. There are documented accounts of explosions caused by air-sampling equipment used by personnel who were trying to determine if there was a hydrogen leak (Zalosh).

Hydrogen, methane, and propane are essentially odorless. Odorants, typically mercaptans, are often added to natural gas and LPG so that leaks can be detected by their smell. However, it is impractical to odorize hydrogen automotive fuels with these

compounds because even very small sulfur concentrations found in these odorants poison fuel cells.

The invisibility of hydrogen flames has been a factor in documented accidents. For example, Zalosh reports on an accident where a hydrogen and hydrocarbon mixture was leaking from a chemical processing heat exchanger. The leak ignited and produced a two foot-long torch flame. The flame appeared to go out when the hydrocarbon flow was turned off. However, as was later learned, the flame simply became invisible and proceeded to melt a 12-foot-long section of the heat exchanger.

Hydrogen flames produce no significant continuum or visible radiation. What little energy is radiated is contained in narrow UV or IR bands that derive from OH and H<sub>2</sub>O. The total energy radiated by hydrogen flames is about an order of magnitude less than that from most other hydrocarbon flames. This makes them very challenging to detect by optical methods; however, this also means that the radiation heat transfer injury or damage from hydrogen fires is much less than that from gasoline or diesel fires.

### **5.3.7 Quenching Distance**

Flame arrestors, which stop flames from propagating, are used on components such as vent stack and electrical enclosures at facilities that flow flammable gases. These devices usually have small openings, typically created by fine-mesh screens, that quench the flame. The size of the opening that quenches the flame, which is called the “quenching distance”, depends on the gas and its concentration and pressure. Hydrogen has an unusually small quenching distance. At one atmosphere, the quenching distance is about 0.06 cm for hydrogen compared to 0.2 cm for propane. The practical safety implications suggest that many flame arrestors suitable for hydrocarbon fuels are unsuitable for use with hydrogen.

### **5.3.8 Liquid Hydrogen Properties**

Liquid hydrogen involves some special risk and safety issues. Large quantities of spilled liquid hydrogen can pool and produce a ground-hugging cold vapor cloud, But as discussed in Section 5.3.2, the liquid evaporates and the cloud diffuses very quickly (e.g., compared to LNG). Any liquid hydrogen uninsulated plumbing or transfer operations present the potential for cryogenic burns. However, the frost and water vapor clouds that naturally form in these areas usually alert personnel to the cold temperatures.

One notable risk results from the fact that hydrogen’s liquefaction temperature (-253°C at 1 atm) is substantially less than the liquefaction temperature of air (-194°C at 1 atm). Uninsulated plumbing containing hydrogen liquid or cold vapor can liquefy the surrounding air. Because oxygen has a higher liquefaction temperature than nitrogen, the liquid is highly enriched in oxygen. An explosive mixture can result if this enriched

liquid air drips on combustible materials such as asphalt (NASA 1997). This is not an issue with LNG, which is warmer than the air liquefaction temperature.

## 5.4 Hydrogen Compared to Natural Gas

The relative safety of using hydrogen and natural gas as automotive fuels is of particular interest because:

- Both hydrogen and natural gas are lighter-than-air gases
- Both fuels are commonly stored as a compressed gas or cryogenic liquid
- There is some substantial experience with CNG and LNG vehicles and fueling stations, but there is less experience with compressed and liquid hydrogen vehicles and stations

There is also discussion within the hydrogen community regarding hydrogen vehicle and fueling station safety codes and standards. Should they be developed by modifying existing natural gas vehicle (NGV) and station codes and standards, or by modifying existing codes and standards for industrial (non-vehicle) hydrogen facilities? For example, a comparison of NGV and hydrogen fueling applications (Campbell) asserts that hydrogen properties and safety requirements are quite different than those for natural gas. Another study, which does not focus on vehicle applications (Zalosh), states, "It is particularly useful to discuss hydrogen safety in comparison to our existing natural gas safety experience."

The relative safety issues pertaining to hydrogen and natural gas use as an automotive fuel and how these are related to the fuels' properties are subsets of the discussion in Section 5.3 and the properties listed in Table 5-1. Table 5-3 summarizes the main implications of differences between key hydrogen and natural gas properties with respect to vehicle and fueling station safety.

## 5.5 Hydrogen Leak, Fire, and Explosion Risk Summary

As explained in Section 5.1, hydrogen may be more or less safe than other candidate automotive fuels, depending on the specific situation. There are many situations where hydrogen is safer than most other fuels. For example, hydrogen itself is nontoxic, while some other fuels are highly toxic. Hydrogen exhaust is harmless, while the exhaust from all other fuels contain toxic CO and the exhaust from some fuels is carcinogenic.

However, situations that might involve leaks, fires, and explosions are of high interest for all fuels. The relative risk and safety of hydrogen in these situations depend on the specific details of the scenario. Table 5-4 summarizes the key properties and characteristics of hydrogen that can make it more prone or less prone to leaks, fires, explosions, and resultant damage or injury relative to other fuels.



**Table 5-3. Summary Comparison of Key Hydrogen and Natural Gas Safety Implications**

Properties <sup>a</sup>	Hydrogen	Natural Gas (Methane)	Implications
Molecular weight	2.016	16.04	Hydrogen is more leak prone
Density at NPT	0.08 kg/m <sup>3</sup>	0.68 kg/m <sup>3</sup>	Hydrogen leaks are substantially more buoyant and they diffuse faster, which causes concentration to drop below LFL more quickly.
Diffusion Coef. at NPT	0.61 cm <sup>2</sup> /sec	0.16 cm <sup>2</sup> /sec	
LFL-UFL in air	4.1-75% Vol.	5.0-15% Vol.	Confined hydrogen leaks into air are more likely to ignite
Min. Ign. Energy	0.02 mJ	0.29 mJ	Liquid hydrogen spills dissipate to less-than-LFL more quickly than LNG spills
Boiling temp. at 1 atm	-253°C	-162°C	
Heat of vap. at 1 atm	446 kJ/kg	509 kJ/kg	Hydrogen-air combustion energy release in a confined volume is less
Volumetric LHV <sup>b</sup>	9,600 kJ/ m <sup>3</sup>	34,000 kJ/ m <sup>3</sup>	Ignited hydrogen-air mixtures are more likely to detonate
Burning velocity	3.0 m/sec	0.36 m/sec	
Leak detectability	low	low	Both hydrogen and natural gas leaks are difficult to detect unless gas is odorized
Flame detectability	low	medium	Hydrogen flames are more difficult to see or detect with instruments

<sup>a</sup>See Table 5-1 for additional details.

<sup>b</sup>At LFL, 1 atm, 15°C

**Table 5-4. Hydrogen Properties and Characteristics That Make it More Prone or Less Prone to Leaks, Fires, and Explosions Relative to Other Fuels**

<b>Properties and Characteristics That Make Hydrogen More Prone to Leaks, Fires, and Explosions Relative to Other Fuels</b>	<b>Properties and Characteristics That Make Hydrogen Less Prone to Leaks, Fires, and Explosions Relative to Other Fuels</b>
<ul style="list-style-type: none"> <li>• Hydrogen is usually stored at very high pressures or low temperatures, both of which increase the potential for leaks.</li> <li>• The hydrogen molecule's small size permits it to leak through air-tight seals. Hydrogen's high sound speed and low viscosity result in a high volumetric leak rate.</li> <li>• Hydrogen leaks are relatively difficult to detect (by either human senses or sensors)</li> <li>• Hydrogen leaks rise (like methane), so it can collect and form combustible mixtures in indoor areas such as non-ventilated ceilings.</li> <li>• Hydrogen's wide flammability range in air and its exceptionally low ignition energy requirement make hydrogen leaks relatively ignition prone.</li> <li>• Hydrogen's high flame speed in air makes these mixtures relatively detonation prone. Deflagrations can progress to detonations in some cases.</li> <li>• Hydrogen flames are relatively difficult to detect (by either human vision or sensors)</li> <li>• Hydrogen's relatively small quenching distance make flame arrestor design more challenging (e.g., some flame arrestors that are effective for other fuels are not effective for hydrogen).</li> </ul>	<ul style="list-style-type: none"> <li>• Hydrogen's low density makes hydrogen leaks extremely buoyant. The rapid upward flow and mixing of hydrogen leaks in open areas results in a relatively small combustible volume. Fuels that leak down (e.g., gasoline, diesel fuel, alcohols, propane) can spread over the ground and engulf large areas in long-duration flames when they are ignited.</li> <li>• Hydrogen's high rate of diffusion in air causes hydrogen releases to diffuse to less-than-flammable concentrations more quickly than other fuels.</li> <li>• Hydrogen's low ignition energy and wide flammability limits can cause hydrogen leaks to ignite immediately and burn as a small steady diffusion flame so that large volumes of combustible mixtures do not accumulate and ignite subsequently.</li> <li>• If hydrogen-air mixtures do accumulate and ignition occurs when the mixture reaches LFL, the resulting energy release and damage potential will be less than with other fuels (due primarily to hydrogen's low density).</li> <li>• Fuels such as diesel fuel and gasoline radiate substantial energy when they burn, which makes these fires more likely to damage or ignite nearby objects or injure humans. Hydrogen fires radiate much less thermal energy.</li> <li>• Because hydrogen fuel cell vehicles are more efficient than internal combustion engine vehicles that use other fuels, they will carry less fuel energy that can be released in case of an accident.</li> </ul>

## 6. CONCLUSIONS

### Objective and Approach Summary

A variety of strategies and fueling station design options are being considered for the current expansion of hydrogen infrastructure. Because there is very little operating experience with any of these, the safety issues are poorly understood. This study identified key safety issues pertaining to four types of hydrogen fueling stations and one type of natural gas fueling station:

- Liquid hydrogen delivery
- Electrolysis onsite production
- Steam methane reforming onsite production
- Compressed hydrogen (tube trailer) delivery
- Conventional compressed natural gas (CNG) station

The key safety issues were identified by defining representative generic designs for these stations and then conducting a top-level FMEA for each type of station. The generic station design definitions included top-level process flow diagrams, P&IDs, equipment specifications, operating procedures, and lists of applicable codes and standards. The FMEA panel included experts in pertinent technical fields and the FMEA process.

Standard FMEA forms were completed for each station design option. These listed the potential failure modes and their causes, effects, and controls. In keeping with the top-level analysis approach, the frequencies and consequences of potential failures were rated in terms of a defined high, medium, and low scale. The FMEA results for each type of station were analyzed by constructing a risk-binning matrix, which summarized the numbers of each of the nine frequency-consequence combinations (i.e., from low-low to high-high).

A general assessment of hydrogen safety issues, which was independent of specific station designs, was also carried out. This assessment was based on a detailed analysis of hydrogen's physical and chemical properties. It compared hydrogen safety issues to those of other fuels in general and natural gas in particular.

### General Station Safety Conclusions

The overarching risk associated with all five types of stations is the potential for a gas release and ignition. Gas releases range from small leaks, for which there are more opportunities, but the consequences are not always severe, to significant discharges (e.g., tank rupture). Many potential sources of gas releases are common to all the types of stations considered. For example, various potential leaks associated with the dispenser including connected drive-away scenarios are rated low-medium or medium-

low in terms of frequency-consequence. On the other hand, various potential failures associated with pressure vessel cascades, most of which result in a substantial release of high-pressure gas, are rated low frequency and high consequence. There are many opportunities for compressor failures that produce leaks, and most of these are rated low frequency and medium consequence.

## **Specific Station Safety Conclusions**

While the dispenser, high-pressure vessel, and compressor components of all the considered station designs are similar, the hydrogen production or delivery and storage components are quite different. Potentially serious failure modes associated with liquid hydrogen delivery and storage include accidental overfilling so as to cause liquid venting (rated high frequency and medium consequence), collisions of the cryogenic tank truck (rated medium frequency and medium consequence), and substantial PSV venting if the storage tank vacuum is lost (rated medium frequency and medium consequence).

Many potential failure modes are associated with an onsite electrolyzer and its related components. These could result in leaks of hydrogen, oxygen, or KOH, and they could also expose personnel to high voltages. However, all of these are rated low in terms of frequency, although some are rated high in terms of consequence.

The only medium-frequency electrolyzer failure involves a dryer malfunction that allows moisture to enter downstream components, and the consequence is rated low because it would probably be detected right away. The component associated with onsite reforming also provides many opportunities for failures that are rated low frequency and medium or high consequence. The only potential failure with a medium frequency rating is a condensate separator malfunction that might produce a fire or explosion, which is given a medium consequence rating. While use of a tube trailer provides relatively few failure opportunities, some of these failures, such as a leak resulting from an impact during change out are given medium frequency and medium consequence ratings. Also, while a tube rupture is a very low frequency possibility, it is certainly a high consequence event.

Factors such as pipeline delivery, natural gas properties, and more experience combine to give conventional CNG stations relatively few failure modes with a high consequence, and all of these are rated as being low frequency.

## **Hydrogen Safety Relative to Other Fuels**

Hydrogen is safer than other fuels in some scenarios and it is less safe in other scenarios. There is not yet enough experience to draw conclusions regarding hydrogen vehicle safety from statistics, and so we can only make projections based on hydrogen

properties. A detailed quantitative comparison of 29 hydrogen properties with those of six other liquid and gaseous fuels was carried out.

Hydrogen is extremely buoyant, and this makes it safer than fuels that are heavier than air (e.g., gasoline, propane) in many leak and other accidental release situations. On the other hand, hydrogen is relatively leak prone, particularly considering the fact that it is usually stored at high pressures, flammable mixtures are easily ignited, and it is difficult to detect. These characteristics may make hydrogen less safe than other fuels in some accident scenarios. While hydrogen's industrial-use safety record is good, this application does not include all vehicle fuel and lay person issues. Fortunately, safety research is underway and codes and standards are being developed to address hydrogen vehicle fuel applications.



# REFERENCES

Lawrence Livermore National Laboratory, *Environment, Safety, and Health Manual, Volume I; Part 3: Safety Analysis and Work Plans and Procedures*; UCRL-AM-133867, Editorial Update: September 23, 2004 [www.llnl.gov/es\\_and\\_h/hsm/doc\\_3.01/doc3-01.pdf](http://www.llnl.gov/es_and_h/hsm/doc_3.01/doc3-01.pdf)

AGA, *AGA LNG Information Book 1981*, American Gas Association Catalog Number X00G81, 1981.

Arthur D. Little, (ADL), *Comparative Risk Assessment of Gasoline, Propane, and NGV Fueling and Conversion Repair Facilities*, Report to the (Canadian) Government-Industry Committee on the Siting of Propane and Natural Gas Trans Fuel Facilities, May 1991.

Browning, L., et al., *Development of a Universal Methanol Fuel Formulation for Use in Both Light- and Heavy-Duty Vehicles, Phase I — Risk Assessment*, Acurex Environmental Final Report 96-115 for NREL, November 1996.

Campbell, K. and Cohen, J., *Why Hydrogen Vehicle Fueling is Different than Natural Gas*, presented at the World NGV 2002 8th International and 20th National Conference and Exhibition, Washington, D.C., October, 2002.

California Air Resources Board (ARB 1999a), *Staff Report: Initial Statement of Reasons, Proposed Regulation for a Public Transit Bus Fleet Rule and Emission Standards for New Urban Buses*, December 1999. Also see [www.arb.ca.gov/regact/bus/bus.htm](http://www.arb.ca.gov/regact/bus/bus.htm)

California Air Resources Board (ARB 1999b), *California Exhaust Emission Standards and Test Procedures for 2003 and Subsequent Model Zero-Emission Vehicles, and 2001 and Subsequent Model Hybrid Electric Vehicles in the Passenger Car, Light-Duty Truck and Medium Duty Vehicle Classes*, December 1999.

DOE AFDC - U.S. Department of Energy Alternative Fuels Data Center: [www.afdc.doe.gov/altfuels.html](http://www.afdc.doe.gov/altfuels.html)

California Hydrogen Highway Network Website: [www.hydrogenhighway.ca.gov/announce/announce.htm](http://www.hydrogenhighway.ca.gov/announce/announce.htm)

Kirk - Othmer Encyclopedia of Chemical Engineering, Alcohol Fuels, Volume 11, 3rd Ed., 1984.

California Legislature website, [www.leginfo.ca.gov/pub/bill/asm/ab\\_0701-0750/ab\\_740\\_bill\\_20030410\\_amended\\_asm.pdf](http://www.leginfo.ca.gov/pub/bill/asm/ab_0701-0750/ab_740_bill_20030410_amended_asm.pdf)

- McDermott, R. *The Basics of FMEA*, Productivity Inc. Portland OR, 1996.
- Murphy, M. J., *Properties of Alternative Fuels*, DOT UMPTA-OH-06-0056-91-9, Dec., 1991.
- NASA 1997, *Safety Standard for Hydrogen and Hydrogen Systems*, NASA NSS 1740.16, Feb., 1997.
- Perry, *Chemical Engineers Handbook, Fifth Edition*, McGraw-Hill, New York, 1973.
- Peschka, W., *Liquid Hydrogen, Fuel of the Future*, Springer-Verlag/Wein, New York, 1992.
- Powars, C., TIAX LLC, *California Hydrogen Fueling Station Guidelines, Consultant Report* for the California Energy Commission, #600-04-002V1, November 2004.
- Rosen, B., Dayen, V., and Proffit, R., *Hydrogen Leak and Fire Detection*, NASA SP-5092, 1970.
- Stamatis, D.H., *Failure Mode and Effect Analysis, FMEA Theory and Execution*, American Society for Quality, ASQ Press, 1995.
- Strehlow, R. A., *Fundamentals of Combustion*, International Textbook Co., Scranton, PA, 1968.
- Swain, M., *Codes and Standards Analysis*, presented at the Hydrogen Fuel Cells & Infrastructure Technologies Program 2003 Merit Review and Peer Evaluation Meeting, Berkeley, CA, May, 2003.
- U.S. Department of Energy (DOE 2003a), *Guidance for Safety Aspects of Proposed Hydrogen Projects*, Hydrogen, Fuel Cells & Infrastructure Technologies Program, July 2003
- U.S. Department of Energy (DOE 2003b), Hydrogen Fuel Cells, Infrastructure Technologies, Section VIB.
- Zalosh, R., and Short, T., *Compilation and Analysis of Hydrogen Accident Reports*, Factory Mutual Research Corp., Final Report C00-4492-4 for DOE, October, 1978.